



ENDO ESSENTIALS

ENDODONTIC PRODUCT CATALOG

How the best perform





SOLUTIONS OVERVIEW



Since 1908 Hu-Friedy has been putting the highest quality, innovative dental products in the hands of dental professionals worldwide. And today as one of the world's leading dental instrument companies, we continue our commitment to advancing dental performance by supporting these products with world class service, support, education and peer communities. We're committed to making sure the best perform that way.

Hu-Friedy. How the best perform.

A Worldwide Focus on Quality

Hu-Friedy is based in Chicago and has been privately owned by the Saslow family since 1959. Today we employ over 600 talented and committed employees in 11 countries – including our production facilities in Chicago and Shanghai, China; our distribution center in Tuttlingen, Germany; and our additional offices in Japan, Germany and Italy. Worldwide, our products are sold in more than 95 countries.

Our mandate for excellence is company-wide. Only at Hu-Friedy will you find more than 300 artisans meticulously handcrafting instruments

in a modern manufacturing facility. Only here are employees personally responsible for the quality of their work and each other's. We believe that our success is the result of both our company's commitment to excellence and the dedication and pride of our highly skilled instrument craftspeople, management and staff.

A Legacy of Innovation

Since the Hu-Friedy Manufacturing Company was founded in 1908 by Hugo Friedman, we have proudly collaborated with private practitioners, dental schools and leading educators to develop

new technologies, innovative designs and quality products that are synonymous with value and performance. Because of our reputation for industry leadership, dental experts have been turning to Hu-Friedy with their cutting-edge ideas for over a hundred years.

From our inception, we have been committed to education and developing relationships with students. At the core is our commitment to helping our customers perform at their best and to improve lives through better dentistry. From student to practitioner, Hu-Friedy is proud to be an important part of our customers' professional lives.

How the best perform





HU-FRIEDY'S ENDODONTIC INSTRUMENTATION

Hu-Friedy's comprehensive line of endodontic instruments and accessories give you versatile options to meet all of your clinical needs. Many of our instruments, especially those made for microsurgical applications, were developed in conjunction with leading global Key Opinion Leaders who are on the cutting-edge of clinical research, design and application. If you are looking for exceptional instrument design, quality and reliability, and unmatched customer service, choose Hu-Friedy's Endodontic Instruments.

The Challenge

The sensitive nature of endodontic procedures necessitates instruments with exceptional response, integrity and durability to accommodate a wide variety of endodontic procedures – from routine root canals to complex microsurgery.

The Solution

Hu-Friedy instruments are individually handcrafted to precise specifications from quality materials to ensure superior performance, longevity and reliability. Instrument design combined with proprietary materials and incomparable workmanship result in instruments with unique balance, working leverage and control. They function as a seamless extension of the practitioner's skill.

The Result

High-quality Hu-Friedy instrumentation provides unsurpassed clinical efficiency, so practitioners can deliver superior outcomes and focus on the patient. The result is outstanding patient care.

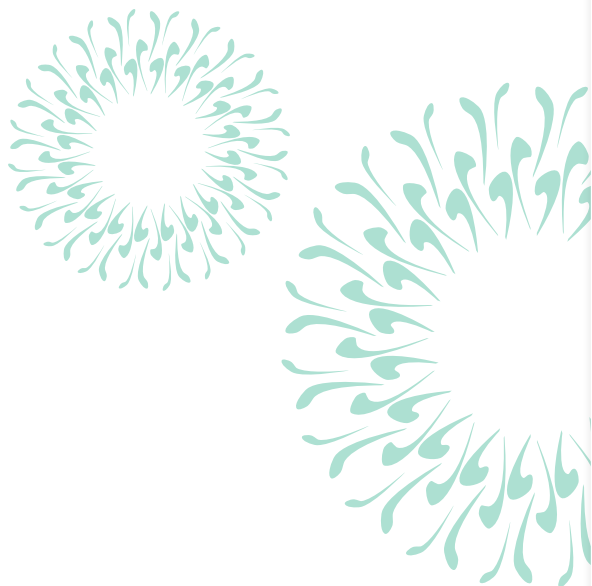

TABLE OF CONTENTS

Endodontic Introduction	3
Endodontic Microsurgery	4
Explorers	14
Excavators	15
Endodontic Accessories	16
Spreaders	17
Pluggers	20
Rubber Dam Clamps	23
RDC Accessories	27
Instrument Management System (IMS®)	29
Key Opinion Leader Kit Lists	33



ENDODONTIC MICROSURGERY

Hu-Friedy has an extensive line of apical hand instruments. This includes curettes, explorers, condensers, burnishers and mirrors. Many were developed in conjunction with Hu-Friedy Key Opinion Leader, Professor Marwan Abou-Rass and other leading global innovators.

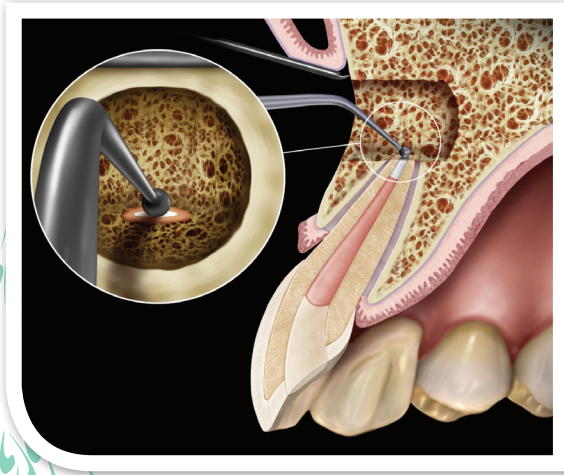
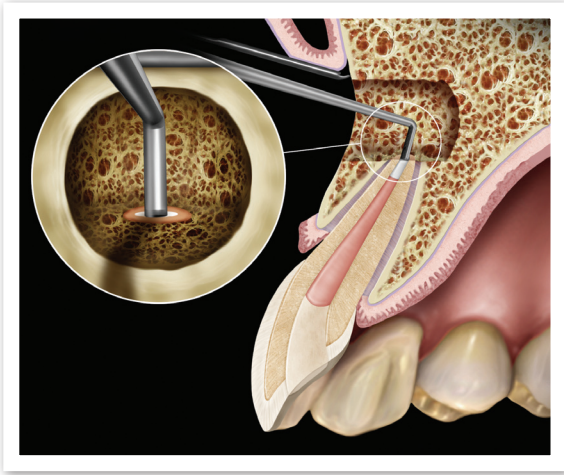
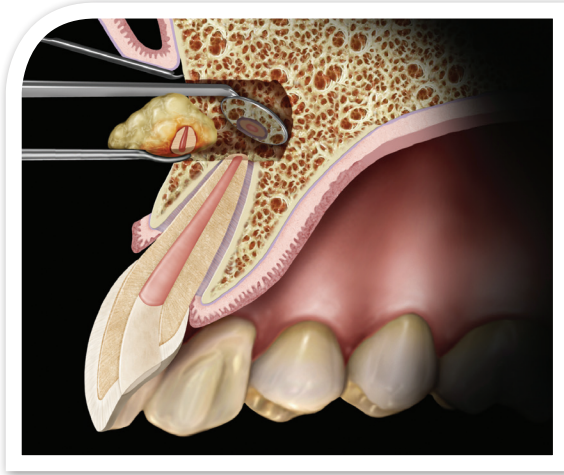

Mirrors

Curettes/
Excavators

Explorers

Filling
Instruments

Condensers/
Pluggers

Combo Plugger/
Burnisher

Retractors



MICROSURGICAL MIRRORS

Hu-Friedy has a large assortment of microsurgical mirrors to choose from. They are made from highly polished stainless steel, come in round or rectangular shapes, are single or double-ended, and are offered in a variety of sizes. Select from single instruments or choose the mirror you want and team it up with a handle of your choice. The rhodium-coated front surface mirrors offer sharp, scratch- and distortion-free visibility.

2 x 7 mm

3 x 9 mm

2.5 mm

4 x 12 mm

4.5 mm

1 Small Rectangular | MM1

2 Medium Rectangular | MM2

3 Large Rectangular | MM3

1 Small Round | MMR

2 Large Round | MMR

FRONT SURFACE RHODIUM-COATED

3 mm

5 mm

2 x 7 mm

3 x 9 mm

Micro Mirror* Round 3 mm | MM4

Micro Mirror* 7 mm x 2 mm | MM7

Micro Mirror* 9 mm x 3 mm | MM8

VELVART

3 x 6 mm

3.5 mm

2 x 6 mm

3.5 mm

1 Velvart | MMVEL1

2 Velvart | MMVEL2

*Handle sold separately. MBW wrench required for assembly.

Handles of the MM1, MM2 and MM3 are marked with one, two or three bands for easy identification.

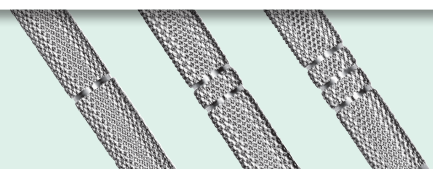



MICROSURGICAL ABOU-RASS CURETTES/EXCAVATORS

Curettes in straight and angled forms, and useful sizes. Straight curettes provide controlled straight line access and good visibility; use angled forms to access difficult or confined areas.

STRAIGHT



1.5 mm

1 Abou-Rass Apical
| MAR-SC1



2.5 mm

2 Abou-Rass Apical
| MAR-SC2



3 mm

3 Abou-Rass Apical
| MAR-SC3



4 mm

4 Abou-Rass Apical
| MAR-SC4

ANGLED



1 mm

1 Abou-Rass
| MAR-C1



2 mm

2 Abou-Rass
| MAR-C2



3.2 mm

3 Abou-Rass
| MAR-C3



4 mm

4 Abou-Rass
| MAR-C4

*The terms "Curettes" and "Excavators" are interchangeable.



Hu-Friedry's large selection of microsurgical explorers are available in various designs and working ends, giving the clinician useful options for exploration and treatment. From the basic and popular MEX1, to Professor Abou-Rass' excellent assortment of explorers, they all provide the balance, fine design and construction that practitioners need for careful yet thorough apical exploration.

DOUBLE-ENDED

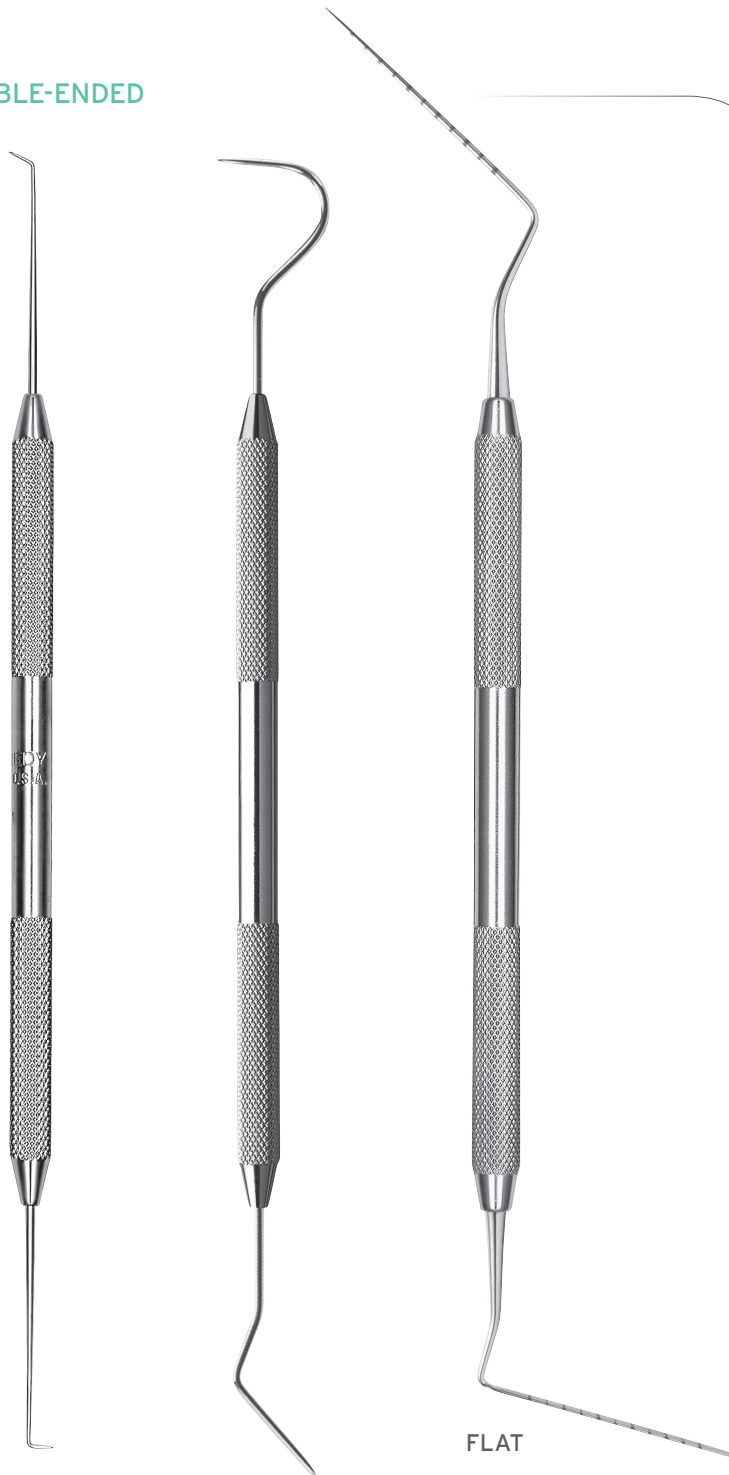

Explorer | MEX1
A popular, basic apical explorer used to initiate the tracking groove in the root tip, and for general exploration and probing.

1 Abou-Rass | MAR-EX1
A versatile explorer with two different, useful and sharp working ends.

3 Abou-Rass | MAR-EX3
A probe with one blunt flat and one round end; excellent for taking measurements, especially the direct root length of the apex.

SINGLE-ENDED



2 Abou-Rass | MAR-EX2
A single-ended bone file styled explorer used to enlarge the opening made by MAR-EX1 into the cortical bone to allow drainage.

4 Abou-Rass | MAR-EX4
Its straight, sharp working end is ideal for penetrating small osseous defects in cortical bone.



5 Abou-Rass | MAR-EX5
A 45° angled explorer used to check dentinal defects, such as root caries, root resorption and fracture lines.

6 Abou-Rass | MAR-EX6
A 90° angled, sharp-pointed explorer useful for detecting apical foramen and apical seal quality.



MICROSURGICAL FILLING INSTRUMENTS & PLUGGERS

RETROFILLING

Hu-Friedy has several double-ended apical filling instruments to choose from, including the recently launched filling instrument developed in conjunction with Dr. Bertrand Khayat, a Hu-Friedy Key Opinion Leader.



Khayat

| PF18ABK6

This versatile Khayat filling instrument has one angled and one straight spatula end. Useful for complex, deep apical treatments.

Left Apical

| MRFL

The left of two paired instruments that are used for filling, condensing and burnishing.

Right Apical

| MRFR

The right of two paired instruments that are used for filling, condensing and burnishing.

PLUGGERS

These pluggers give the clinician very different working ends for enhanced maneuvering and versatility.

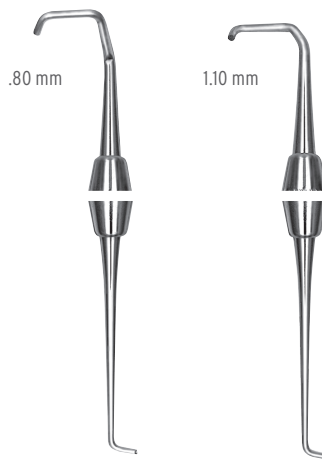

1

| PLGRF1

2

| PLGRF2

The Khayat and Velvart pluggers are useful for deep canal condensation, and can be used together for this purpose. Designed in conjunction with Dr. Bertrand Khayat and Dr. Peter Velvart.



Khayat

| PLGBK6

Velvart

| PLGVEL56

MICROSURGICAL ABOU-RASS CONDENSERS/PLUGGERS



Designed in conjunction with Professor Abou-Rass, these double-ended instruments are perfect for retrofill applications. They are double-ended with one round and one oval tip. Round working tips produce "pot hole" preparations while oval tips make "isthmus" designs.

STRAIGHT

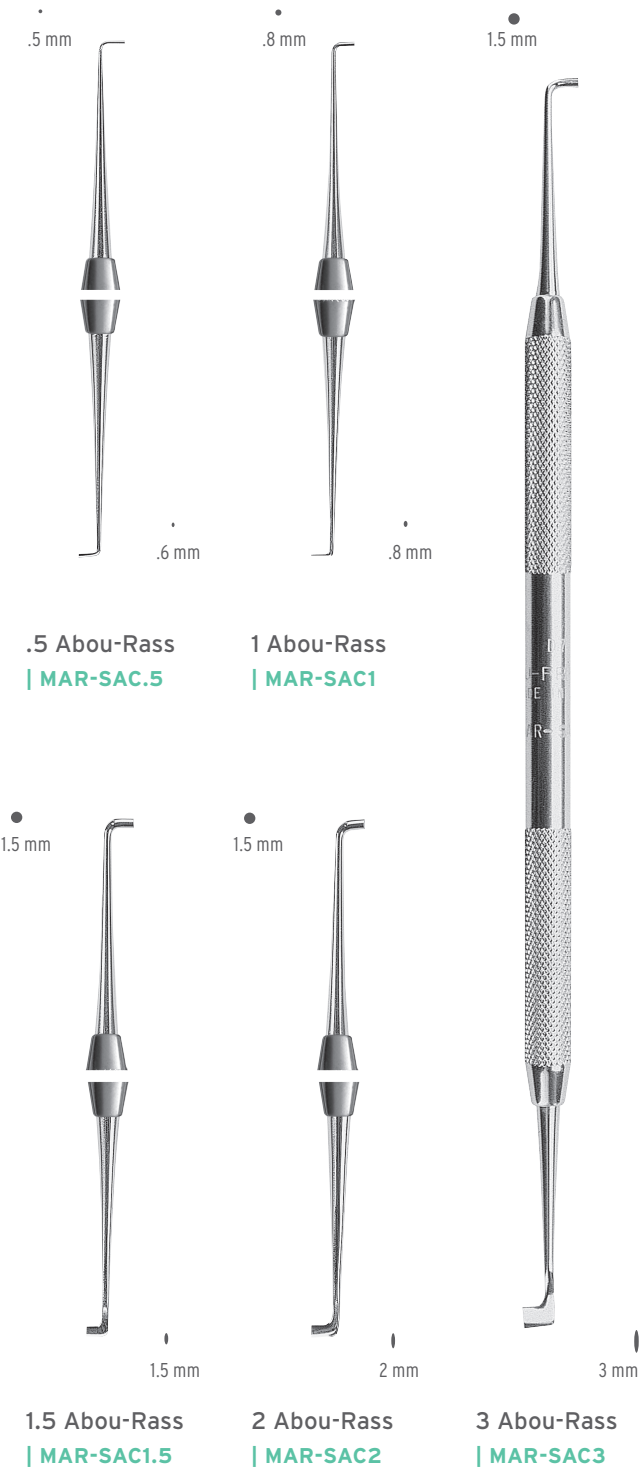

ANGLED



*The terms "Condensers" and "Pluggers" are interchangeable.



MICROSURGICAL CONDENSERS/BURNISHERS

These versatile double-ended instruments combine a condenser on one end and a ball burnisher on the other end. The plugger ends feature universal, right and left designs and come in small, medium and large sizes.



Large Left
| MCBLL



Large Right
| MCBRL



Medium Right
| MCBRM



Medium Left
| MCBLM



Small Right
| MCBRS



Small Left
| MCBLS



Universal Small
| MCBUS



Universal Medium
| MCBUM



Universal Large
| MCBUL

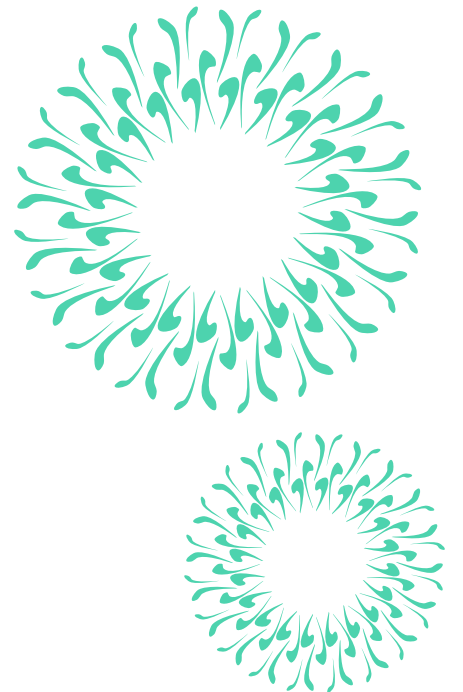

This family of ball burnishers is available in straight and angled forms. Straight designs provide direct, straight access with ease and visibility. The angled forms have long shanks for optimal reach and visibility of the working end.

MICROSURGICAL ABOU-RASS BURNISHERS



STRAIGHT

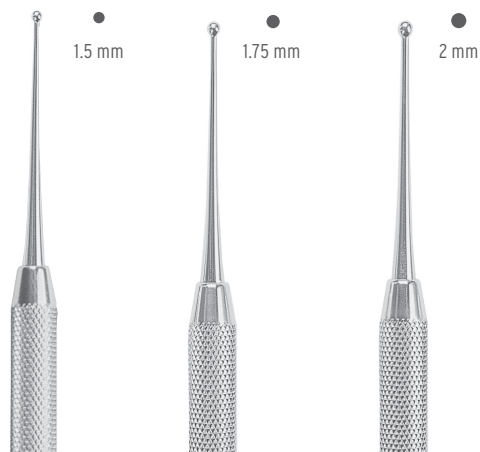

1.5 mm

1.75 mm

2 mm

2 Abou-Rass
| MAR-SB2

3 Abou-Rass
| MAR-SB3



2.25 mm

2.5 mm

1 Abou-Rass
| MAR-SB1

4 Abou-Rass
| MAR-SB4

5 Abou-Rass
| MAR-SB5

ANGLED



0.5 mm

1 mm

1.25 mm

2 Abou-Rass
| MAR-B2

3 Abou-Rass
| MAR-B3



1.75 mm

2 mm

1 Abou-Rass
| MAR-B1

4 Abou-Rass
| MAR-B4

5 Abou-Rass
| MAR-B5



EXPLORERS

Hu-Friedy's endodontic explorers are made from a special blend of alloy which provides the flexibility, strength, tactile sensitivity and resilience clinicians need when exploring and assessing the treatment site. They are available in several double-ended designs and handles.

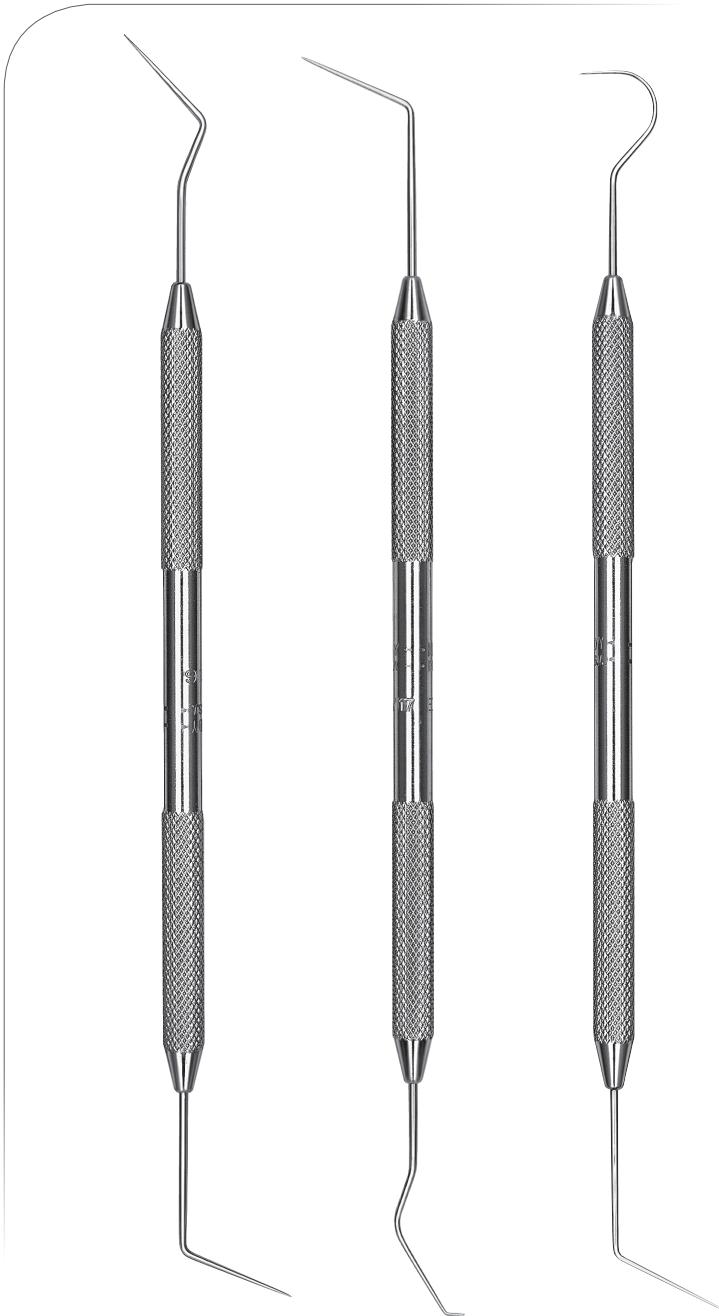
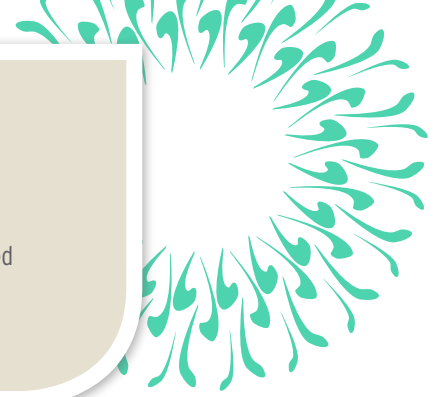

DG16
| EXDG16
Handle options: #6, #7, #31
| EXDG16T

DG16/17
| EXDG16/17
Handle: #31

DG16/23
| EXDG16/23
Handle: #31

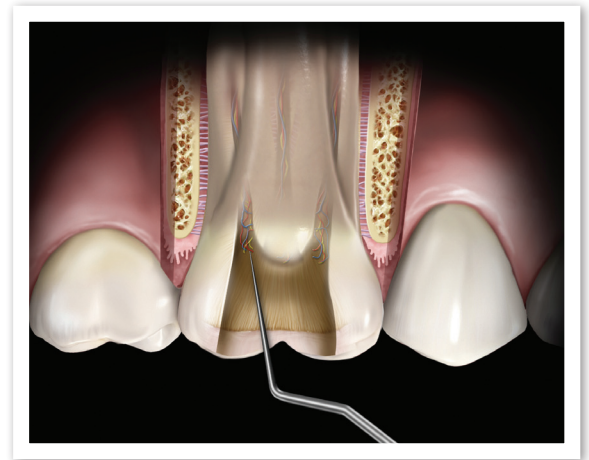

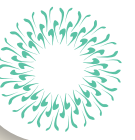

EXCAVATORS

Hu-Friedy's endodontic excavators feature extended-length shanks and are meticulously handcrafted from the highest grade stainless steel. They help the clinician access the pulp chamber for easy and efficient removal of dentin. The result is a superior clinical outcome and improved efficiency.

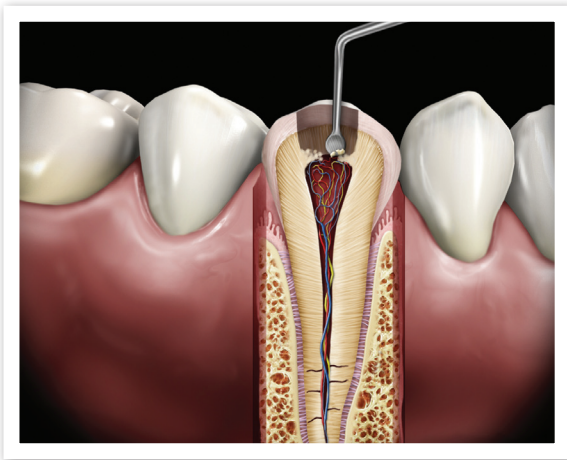

2 Glick
| EXCGL2

31L
| EXC31L
Handle options:
#6, #41

31W
Oval Spoon
| EXC31W
Handle options:
#6, #41

32L
| EXC32L
Handle options:
#6, #41

33L
| EXC33L
Handle options:
#6, #41





ENDODONTIC ACCESSORIES

In addition to critical procedural instruments such as spreaders, pluggers and rubber dam clamps, endodontic accessories, the "staples" of the office, are available to complete the line-up of Endo Essentials.

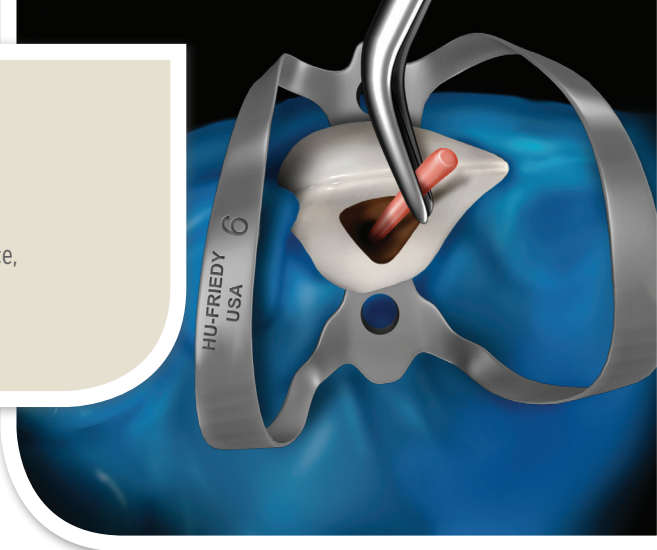

POST & SILVER POINT REMOVAL FORCEPS



Steiglitz Straight
5-1/2" (14 cm)*

| RFSTR



Steiglitz (Archer) 45°
5-1/4" (13-1/2 cm)*

| RF45



Steiglitz 90°
4-3/4" (12 cm)*

| RF90

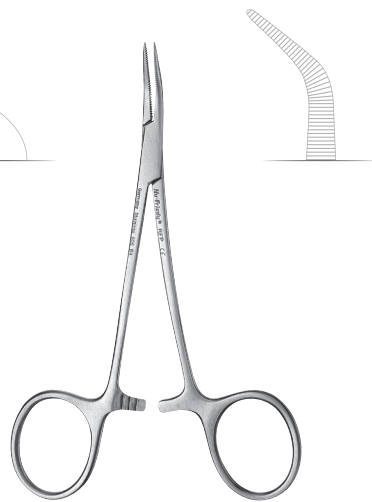

Peet 45°
4-3/4" (12 cm)*

| RFP



1 Mirror Handle
| MH6692K
With millimeter
scale.



6" Stainless
Steel Ruler
| CLR6



6-1/2"
(16-1/2 cm)
Locking
Pliers
| EPL1

*Pictured at 50%.

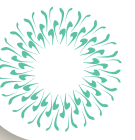

SPREADERS

Hu-Friedy manufactures a wide variety of spreaders, all handcrafted from the finest stainless steel to precise specifications. Choose from NiTi spreaders, ISO sized spreaders with color coded handles for easy identification, heat carriers, and a variety of other popular spreaders. Our spreaders help the clinician gain access into the most difficult canals for optimal compaction of filling material during lateral condensation.

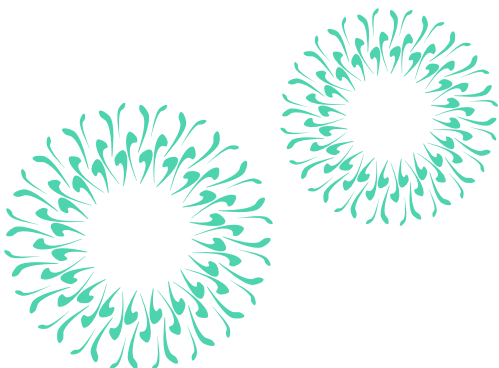
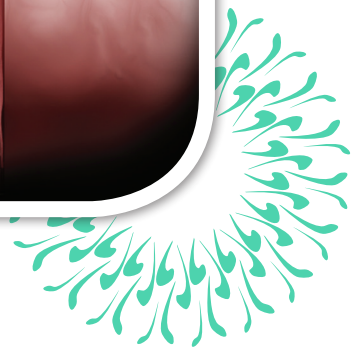
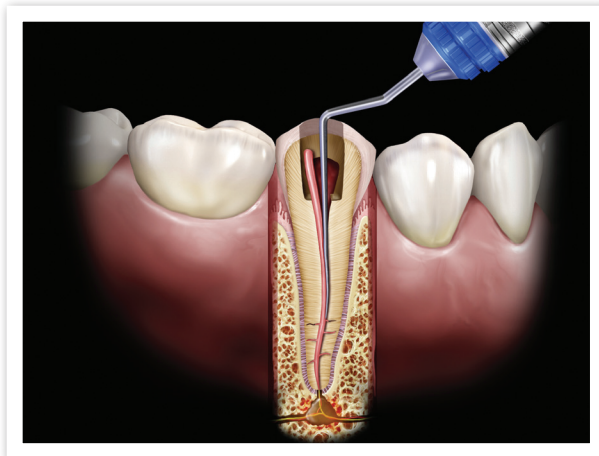
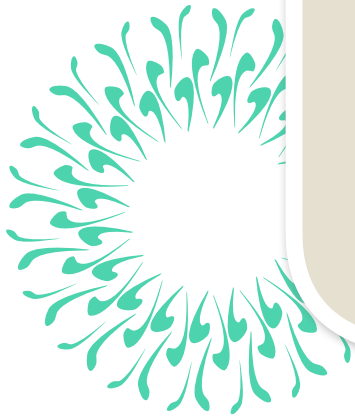



SPREADERS*

ISO SIZED SPREADERS*

ISO sized spreaders are color-coded for identification and convenience.

.25 mm



GP1
20 mm
| RCSGP1

.30 mm



1S Wakai
22 mm
| RCSW1S

.40 mm



2S Wakai
22 mm
| RCSW2S

.30 mm



ISO Size 30
24 mm
| RCS30

.40 mm

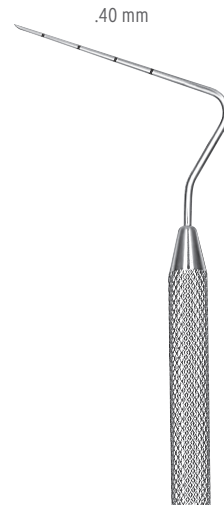

ISO Size 40
24 mm
| RCS40

.40 mm



D11 Standard
23 mm
| RCSD11

.35 mm



D11S Thin
23 mm
| RCSD11S

.23 mm



D11T Thinner
22 mm
| RCSD11T

.20 mm



D11TS Thinnest
21 mm
| RCSD11TS

.50 mm



ISO Size 50
28 mm
| RCS50

.60 mm

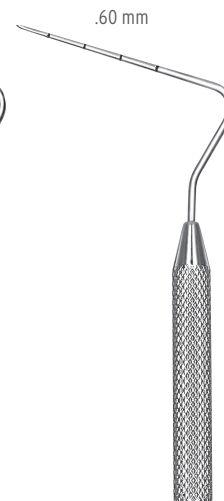

ISO Size 60
28 mm
| RCS60

ISO Spreaders have an ISO color-coded band on the handle for ease of identification during usage: #30-Blue, #40-Black, #50-Yellow, #60-Blue

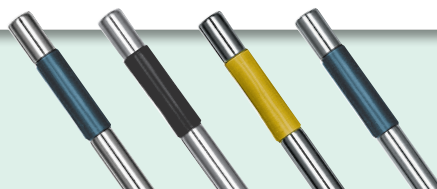

*D1=Diameter of instrument 1 mm from the tip. These measurements (i.e., .30) appear next to the tips of the instruments.



NICKEL TITANIUM ENDODONTIC SPREADERS*

Nickel Titanium, or NiTi, points provide these spreaders with extra flexibility and “memory” while the ergonomic, color-coded Satin Steel handles provide maximum comfort, control and easy identification. Choose from nine popular designs.

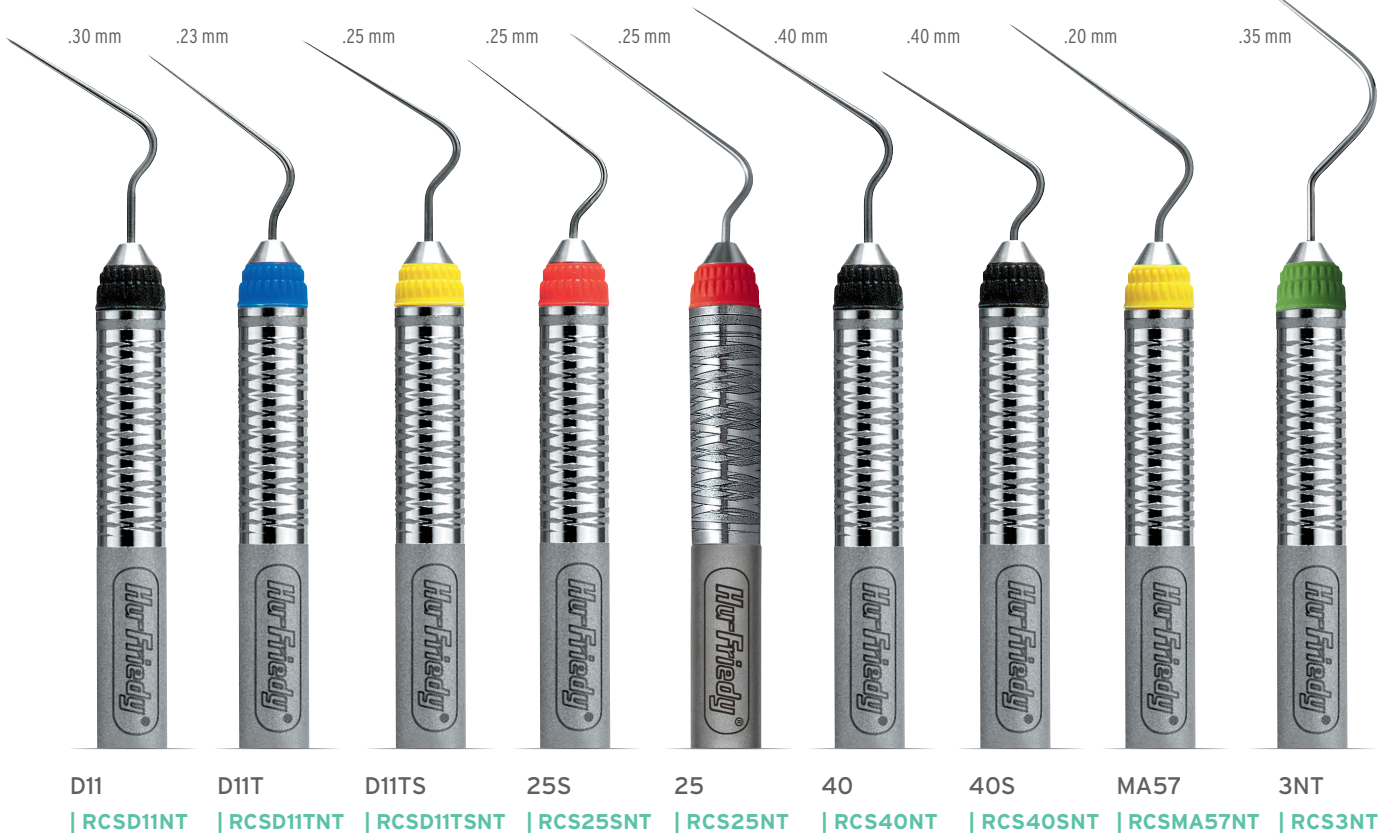

HEAT CARRIERS*

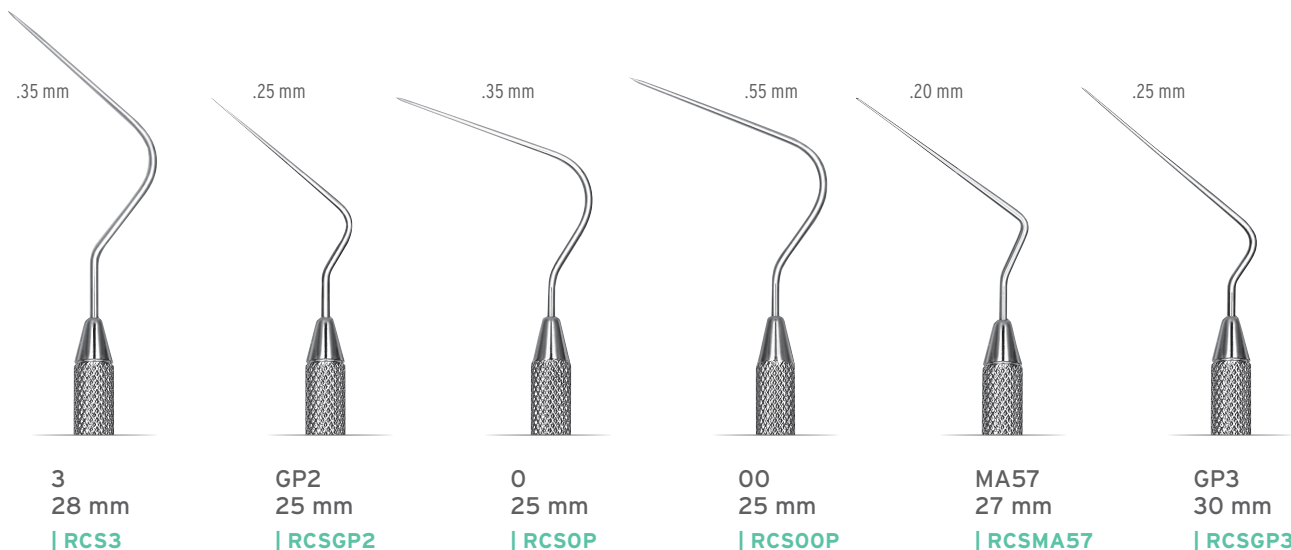

*D1=Diameter of instrument 1 mm from the tip. These measurements (i.e., .30) appear next to the tips of the instruments.



PLUGGERS

When performing vertical condensation, choose from ISO-sized anterior or posterior options, Machtou, the Glick Blade/Plugger or other options. These pluggers are handcrafted to exact specifications using the finest materials.

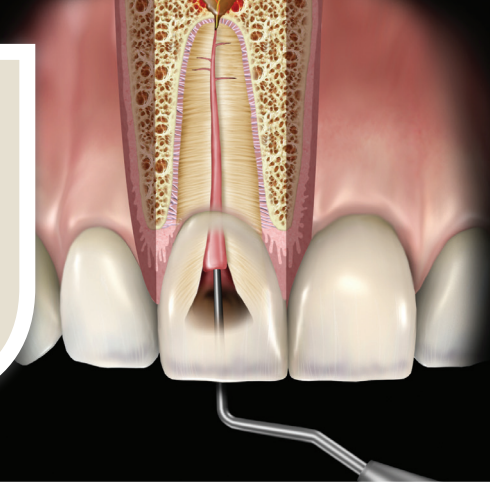

ISO SIZED PLUGGERS*

.30 mm



ISO Size 30
24 mm
| RCP30

.40 mm



ISO Size 40
24 mm
| RCP40

.50 mm



ISO Size 50
24 mm
| RCP50

.60 mm



ISO Size 60
24 mm
| RCP60

.40 mm



1/3
21 mm
| RCP1/3

.50 mm



5/7
21 mm
| RCP5/7

1.00 mm



9/11
21 mm
| RCP9/11

.50 mm



1/2 Machtou
Root Canal
Plugger
| RCPM1/2

.80 mm

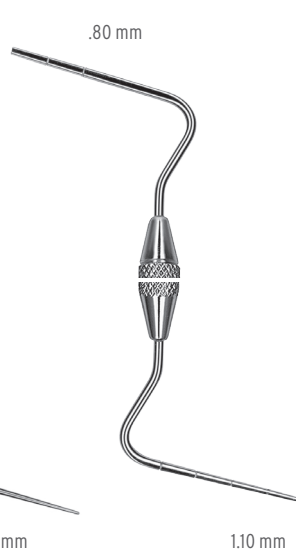

3/4 Machtou
Root Canal
Plugger
| RCPM3/4

.45 mm

.75 mm

1.15 mm

.60 mm

1.10 mm



1 Glick Blade/
Plugger
| RCPGL1
Handle options: #6, #7, #41

ISO Pluggers have an ISO color-coded band on the handle for ease of identification during usage: #30-Blue, #40-Black, #50-Yellow, #60-Blue.

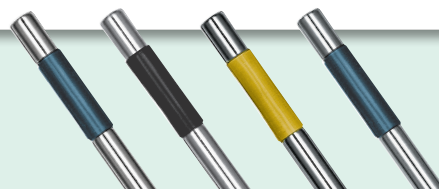

*D1=Diameter of instrument 1 mm from the tip. These measurements (i.e., .30) appear next to the tips of the instruments.



SLEIMAN PLUGGERS / HEAT CARRIERS

.40mm - .74 mm .50mm - .80 mm .66mm - .96 mm .78mm - 1.20 mm .90mm - 1.45 mm



Sleiman Root Canal Plugger
| RCPSL172

Sleiman Root Canal Plugger
| RCPSL275

Sleiman Root Canal Plugger
| RCPSL376

Sleiman Root Canal Plugger
| RCPSL478

Sleiman Root Canal Plugger
| RCPSL577

TAPERED WORKING END

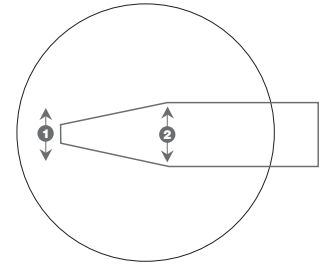

	①	②
RCPSL172	0.40 mm	0.74 mm
RCPSL275	0.50 mm	0.80 mm
RCPSL376	0.66 mm	0.96 mm
RCPSL478	0.78 mm	1.20 mm
RCPSL577	0.90 mm	1.45 mm

LUKS

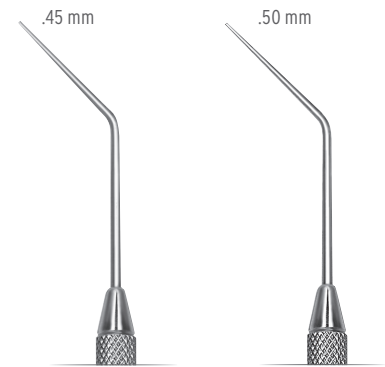

L1
18 mm
| RCPL1

L2
18 mm
| RCPL2

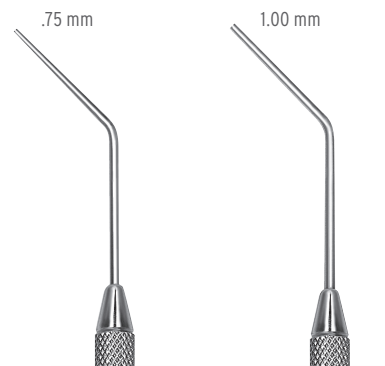

L3
18 mm
| RCPL3

L4
18 mm
| RCPL4

*D1=Diameter of instrument 1 mm from the tip. These measurements (i.e., .30) appear next to the tips of the instruments. Marked at 5 mm intervals to assess penetration depth.



ANTERIOR

Anterior condensers are 7 mm longer than posterior condensers.

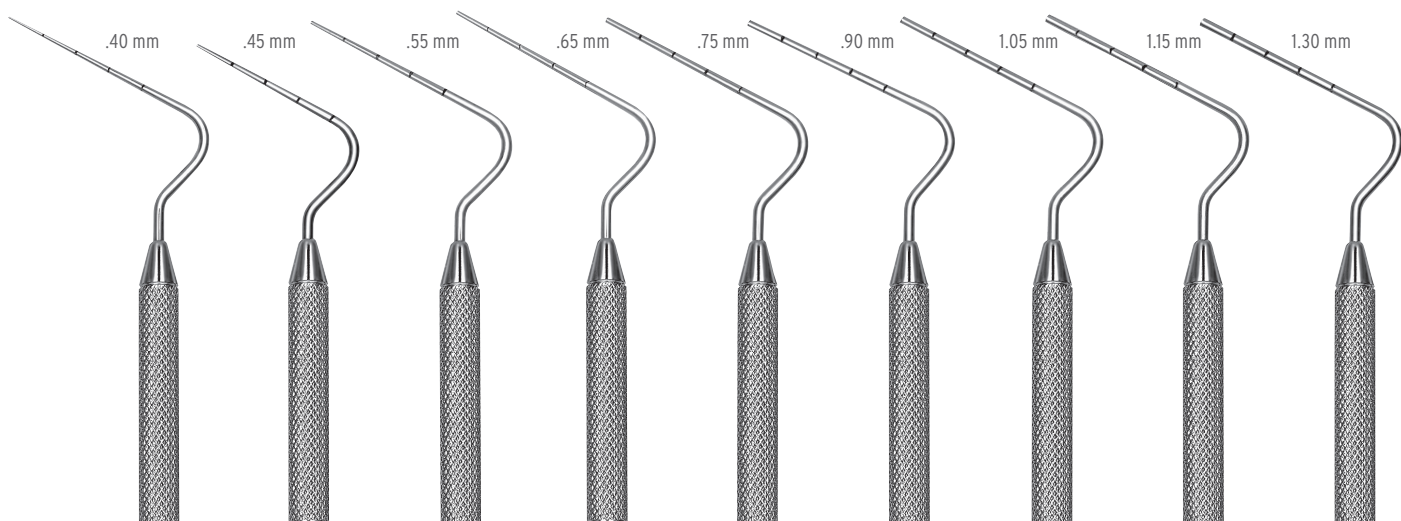

8A
29 mm

| RCP8A

8-1/2A
29 mm

| RCP8-1/2 A

9A
29 mm

| RCP9A

9-1/2 A
29 mm

| RCP9-1/2A

10A
29 mm

| RCP10A

10-1/2A
29 mm

| RCP10-1/2A

11A
29 mm

| RCP11A

11-1/2A
29 mm

| RCP11-1/2A

12A
29 mm

| RCP12A

POSTERIOR

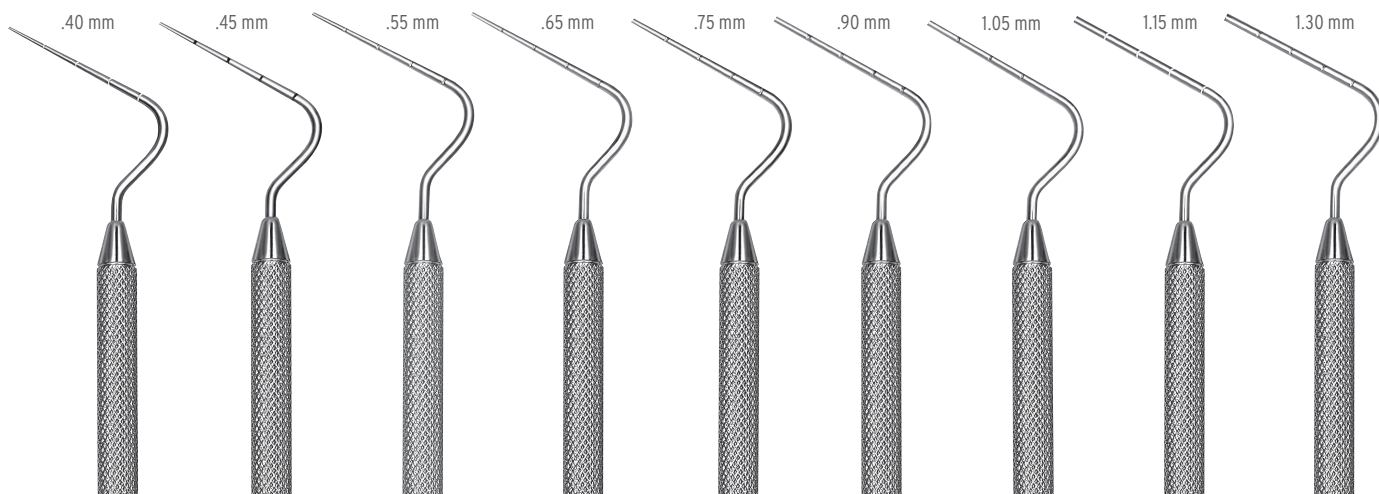

8
22 mm

| RCP8

8-1/2
22 mm

| RCP8-1/2

9
22 mm

| RCP9

9-1/2
22 mm

| RCP9-1/2

10
22 mm

| RCP10

10-1/2
22 mm

| RCP10-1/2

11
22 mm

| RCP11

11-1/2
22 mm

| RCP11-1/2

12
22 mm

| RCP12

*DI=Diameter of instrument 1 mm from the tip. These measurements (i.e., .40) appear next to the tips of the instruments. The terms "Condensers" and "Pluggers" are interchangeable.

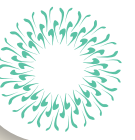

RUBBER DAM CLAMPS

Hu-Friedy rubber dam clamps are made in the USA from proprietary Satin Steel for corrosion resistance, superior strength, and a fine balance between flexibility and memory. The matte finish on all 48 styles absorbs and dissipates light instead of reflecting it back, so you can experience a comfortable field of vision that is easier on the eyes – to help you perform at your best.

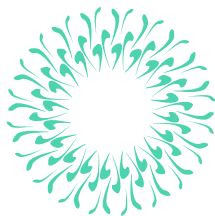
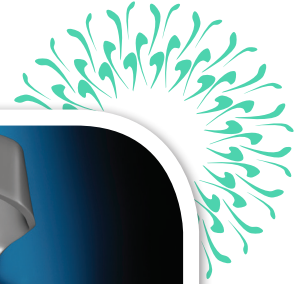
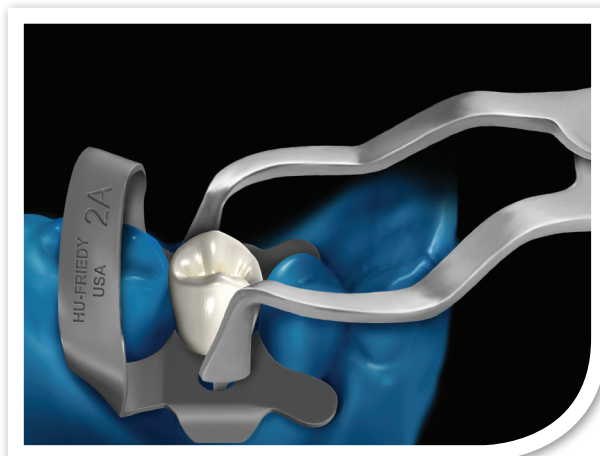
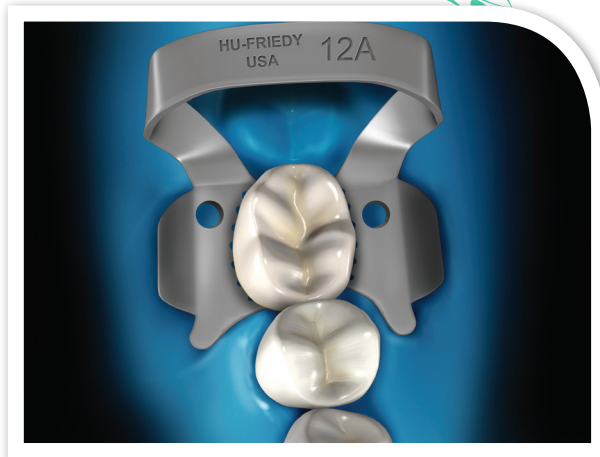



RUBBER DAM CLAMPS

A complete line of Satin Steel® Rubber Dam clamps for anterior, premolar and molar applications.

ANTERIOR

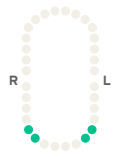

00

| RDCM00

Flat jaws and high bow for small lower canines and first premolars.

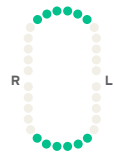

6

| RDCM6

Slightly offset jaws for labial caries on anterior teeth.

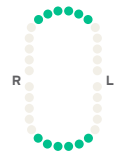

9

| RDCM9

Offset flat jaws and stiff bow for anterior teeth.

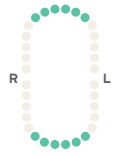

9S

| RDCM9S

Offset flat serrated jaws for anterior teeth.

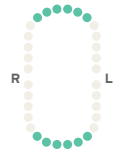

212

| RDCM212

Flat jaws for labial caries on anterior teeth.

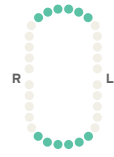

212SA

| RDCM212SA

Slightly offset staggered jaws for odd shaped anteriors.

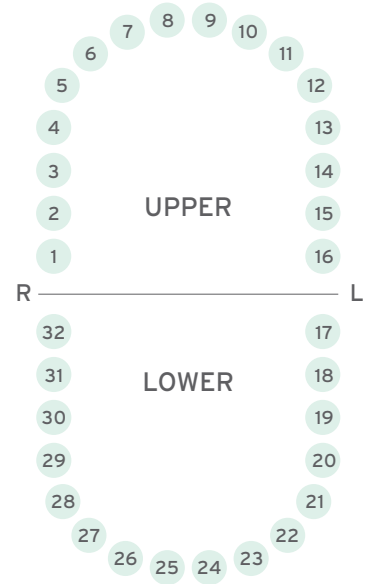

PREMOLARS

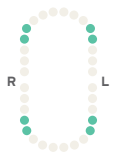

0

| RDCM0

Flat jaws and high bow for longer premolars.

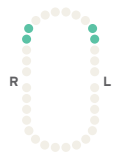

1

| RDCM1

Slightly festooned jaws for upper premolars.

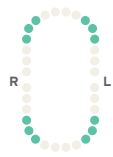

1A

| RDCM1A

Deeply festooned jaws for canines and premolars.



2

| RDCM2

Flat jaws for premolars.

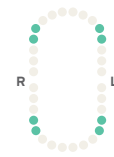

2A

| RDCM2A

Flat jaws for larger premolars.

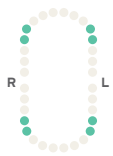

2AS

| RDCM2AS

Flat serrated jaws for larger premolars.

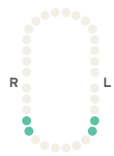

W2

| RDCMW2

Flat jaws for premolars.

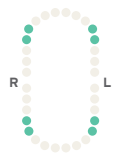

27N

| RDCM27N

Slightly festooned jaws for premolars.



29

| RDCM29

Flat jaws for lower premolars.



209

| RDCM209

Small, flat jaws with stiff bow for lower premolars.





MOLARS (GENERAL)

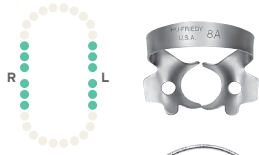

8A
| **RDCM8A**
Deeply festooned four-point jaws for molars.

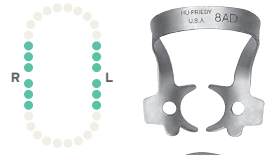

8AD
| **RDCM8AD**
Deeply festooned jaws and extended bow for distal access to molars.



W8A
| **RDCMW8A**
Slightly festooned jaws for molars.



10
| **RDCM10**
Flat jaws designed for small upper left and lower right molars; paired with RDCM11.



11
| **RDCM11**
Flat jaws designed for small upper right and lower left molars; paired with RDCM10.

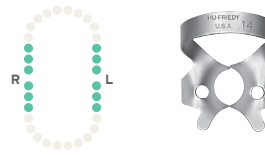

14
| **RDCM14**
Deeply festooned jaws for partially erupted or irregularly shaped molars.

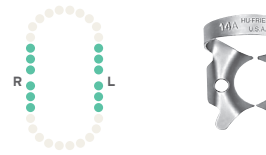

14A
| **RDCM14A**
Deeply festooned jaws for partially erupted or irregularly shaped molars; larger than RDCM14.



W14A
| **RDCMW14A**
Deeply festooned jaws for partially erupted or irregularly shaped molars.



18
| **RDCM18**
Flat jaws and stiff bow for molars.



24
| **RDCM24**
Flat jaws for upper right and lower left molars; paired with RDCM25.



25
| **RDCM25**
Flat jaws for upper left and lower right molars; paired with RDCM24.

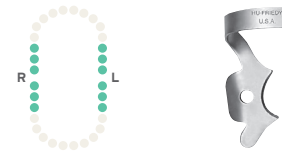

27
| **RDCM27**
Flat jaws for large molars.

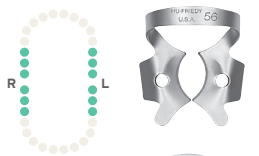

56
| **RDCM56**
Slightly festooned jaws for large molars.

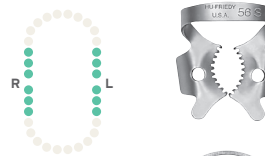

56S
| **RDCM56S**
Slightly festooned serrated jaws for large partially erupted or irregularly shaped molars.

The Satin Steel matte finish reduces operatory light reflection for a comfortable field of vision that is easy on the eyes so you can perform at your best.



RUBBER DAM CLAMPS

UPPER MOLARS



4
| RDCM4
Flat narrow jaws for small upper molars.



W4
| RDCMW4
Flat narrow jaws for small upper molars.

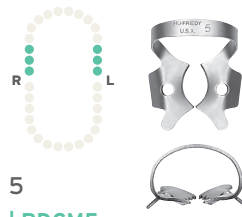

5
| RDCM5
Slightly festooned jaws for large upper molars.

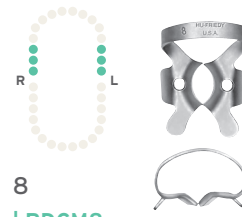

8
| RDCM8
Deeply festooned jaws for upper molars.



26N
| RDCM26N
Flat jaws for upper molars.



30
| RDCM30
Offset jaws for upper right molars; paired with RDCM31.

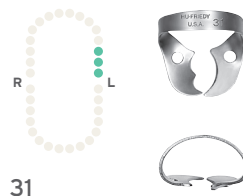

31
| RDCM31
Offset jaws for upper left molars; paired with RDCM30.

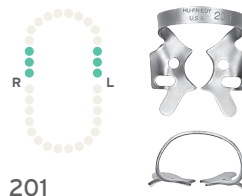

201
| RDCM201
Slightly festooned jaws for upper molars.

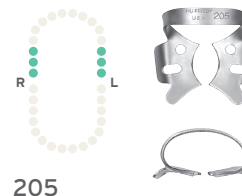

205
| RDCM205
Slightly festooned jaws for large upper molars.

LOWER MOLARS

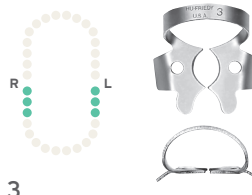

3
| RDCM3
Flat narrow jaws for small lower molars.

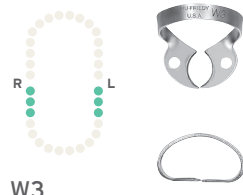

W3
| RDCMW3
Flat narrow jaws for small lower molars.

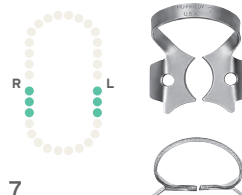

7
| RDCM7
Flat jaws for lower molars.

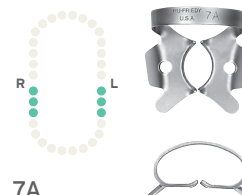

7A
| RDCM7A
Slightly reversed festooned jaws for large lower molars.



W7
| RDCMW7
Flat jaws for lower molars.

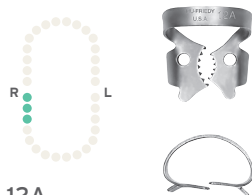

12A
| RDCM12A
Serrated offset jaws for lower right molars; paired with RDCM13A.

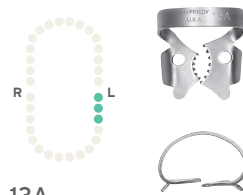

13A
| RDCM13A
Serrated offset jaws for lower left molars; paired with RDCM12A.

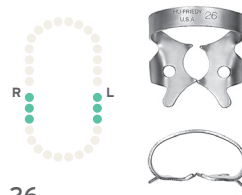

26
| RDCM26
Slightly reversed festooned jaws for small lower molars.

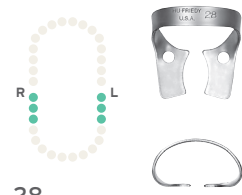

28
| RDCM28
Flat jaws for lower molars.



RUBBER DAM CLAMP ACCESSORIES & KITS

Rubber Dam Clamp Organizing Board*

| RDCOB

Store, sterilize and organize with eight pegs that securely hold your clamps. Clamps not included.

Dimensions:
4.62" x 2.4" x .375"
(117 mm x 61 mm x 10 mm)

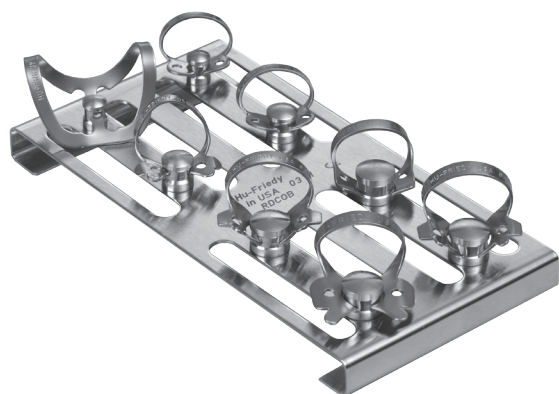

Our line of 48 Satin Steel matte finish rubber dam clamps wouldn't be complete without these endo-essential accessories and kits. The IMS section of Endo Essentials includes IMS part boxes that are useful for clamp storage and sterilization.

RUBBER DAM TEMPLATES

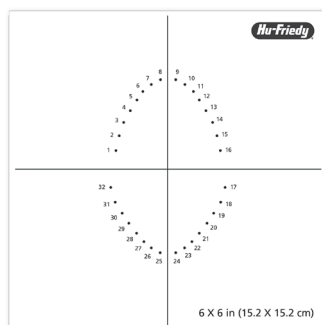

Universal Rubber Dam Template**

| RDTUNIV

Adult template shown.
Pedodontic template also included.

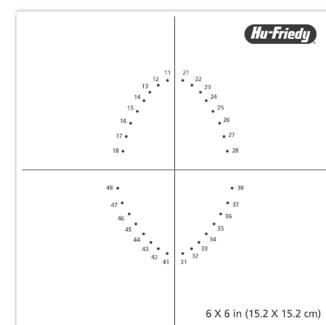

FDI Rubber Dam Template**

| RDTFDI

Adult template shown.
Pedodontic template also included.

RUBBER DAM CLAMP FORCEPS



4
7" (17-1/2 cm)**

| RDF4

Rubber Dam
Forceps
6-1/2" (17 cm)**

| RDF

RUBBER DAM FRAMES

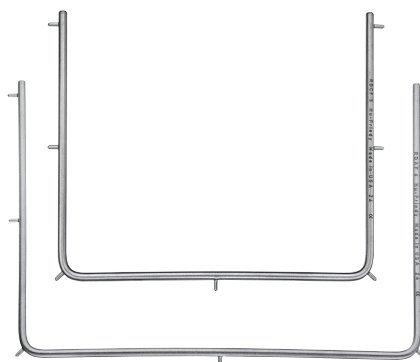

Rubber
Dam Frame
Child 5"
(13 cm)**

| RDCF5

Rubber
Dam Frame
Adult 6"
(15 cm)**

| RDAF6

RUBBER DAM PUNCHES



Rubber Dam
Punch
6-3/4" (16 cm)**

| RDP

Ainsworth
6-3/4" (17-1/2 cm)**

| RDPA

**Pictured at 50%.



RUBBER DAM KITS

Rubber Dam kits and collections give clinicians more choices, from an entire kit to basic clamp set-ups.

Rubber Dam Kit

| RDKIT

Basic items needed for rubber dam procedures conveniently packaged in a kit (also available individually).

Rubber Dam Clamp Forceps	RDF
Rubber Dam Punch	RDP
Rubber Dam Frame-Adult	RDAF6
Universal Rubber Dam Template	RDTUNIV
FDI Rubber Dam Template	RDTFDI
Rubber Dam Clamp Organizing Board	RDCOB
#0 Satin Steel Rubber Dam Clamp	RDCM0
#1 Satin Steel Rubber Dam Clamp	RDCM1
#2 Satin Steel Rubber Dam Clamp	RDCM2
#7 Satin Steel Rubber Dam Clamp	RDCM7
#8 Satin Steel Rubber Dam Clamp	RDCM8
#8A Satin Steel Rubber Dam Clamp	RDCM8A
#14A Satin Steel Rubber Dam Clamp	RDCM14A
#212 Satin Steel Rubber Dam Clamp	RDCM212

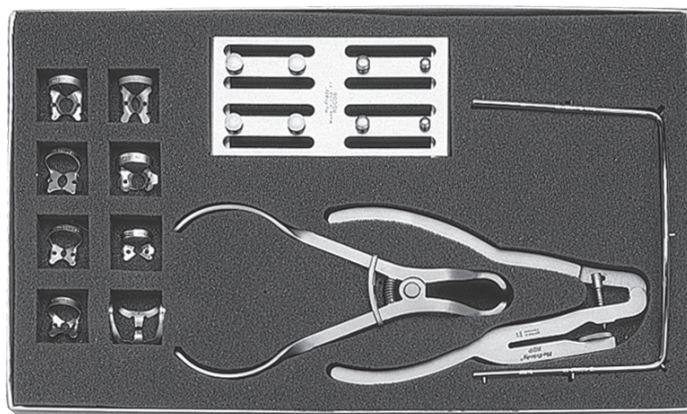
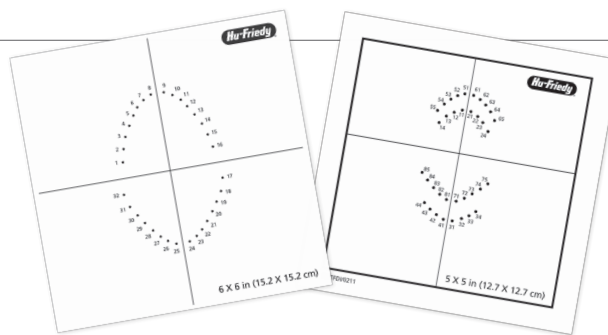

Rubber Dam Clamp 7 Pack

| RDCSET7

#00 Satin Steel Rubber Dam Clamp	RDCM00
#2 Satin Steel Rubber Dam Clamp	RDCM2
#7 Satin Steel Rubber Dam Clamp	RDCM7
#8 Satin Steel Rubber Dam Clamp	RDCM8
#8A Satin Steel Rubber Dam Clamp	RDCM8A
#9 Satin Steel Rubber Dam Clamp	RDCM9
#14A Satin Steel Rubber Dam Clamp	RDCM14A



Rubber Dam Clamp 8 Pack

| RDCSET

#0 Satin Steel Rubber Dam Clamp	RDCM0
#1 Satin Steel Rubber Dam Clamp	RDCM1
#14A Satin Steel Rubber Dam Clamp	RDCM14A
#2 Satin Steel Rubber Dam Clamp	RDCM2
#212 Satin Steel Rubber Dam Clamp	RDCM212
#7 Satin Steel Rubber Dam Clamp	RDCM7
#8 Satin Steel Rubber Dam Clamp	RDCM8
#8A Satin Steel Rubber Dam Clamp	RDCM8A



HU-FRIEDY'S INSTRUMENT MANAGEMENT SYSTEM

Hu-Friedy's Instrument Management System, IMS, is the most comprehensive, reliable and complete instrument processing and infection control system on the market today. Your instruments are protected and secure so they last longer. Your staff benefits because instrument handling is decreased. Hu-Friedy's long lasting, low maintenance stainless steel cassettes hold each procedural set-up through the entire cleaning, sterilization, storage and presentation cycle. IMS was designed for you and your busy practice—it's adaptable, flexible, easy, safe and efficient.

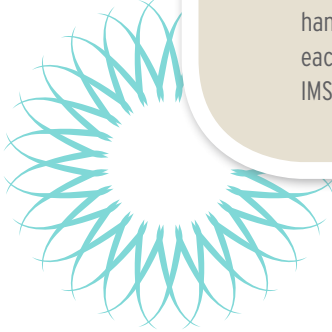

1. Chairside: Patient Preview & Presentation

- Systematically organizes instruments according to procedure type, allowing for more focus on patients and less time spent looking for missing instruments
- Neatly organized instruments offer more professional appearance and can help enhance referrals

2. Cleaning: Processed & Prepped

- Instruments are kept together throughout cleaning, rinsing and drying, reducing the potential for breakage or loss
- Allows for less handling of instruments, reducing the chance for sharps injuries

3. Sterilization: Neat & Complete

- Cassettes with instruments are packaged and placed in autoclave together to help reduce consumable usage
- Reduced handling of instruments provides safer protocol and minimizes liability

4. Storage: Wrapped & Ready

- Ready for use or storage until needed for increased time savings
- Complete procedural set-ups for easy set-up and teardown

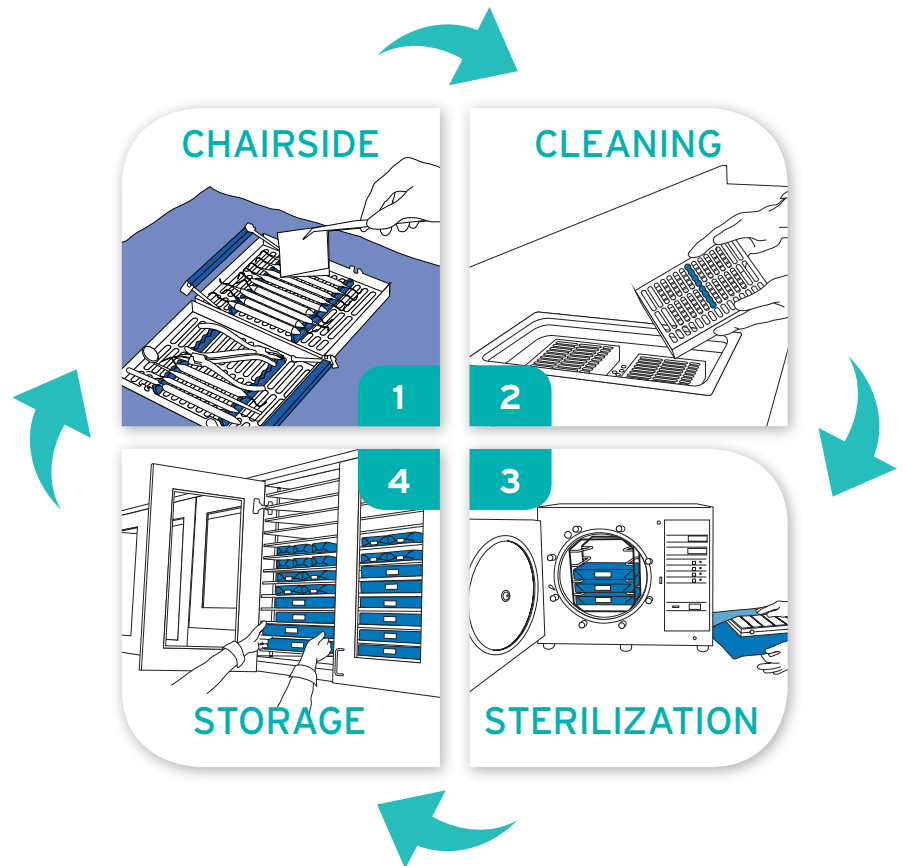



POINTS OF PERFORMANCE

Ergonomic latch with positive locking mechanism is safe and easy-to-use, allows one-handed opening and visual confirmation if the cassette is locked / unlocked. (Figure 2)

Revolutionary new hole pattern design creates 30% additional open area for more access during cleaning and sterilization, and is compatible with current cleaning equipment, including automated washers.

Innovative color-coded silicone rail system, available in 11 color options, significantly reduces instrument contact by up to 59%, allowing for more water flow while protecting the instruments during reprocessing. (Figure 1)

High quality, electropolished stainless steel protects against corrosion while providing a professional appearance.

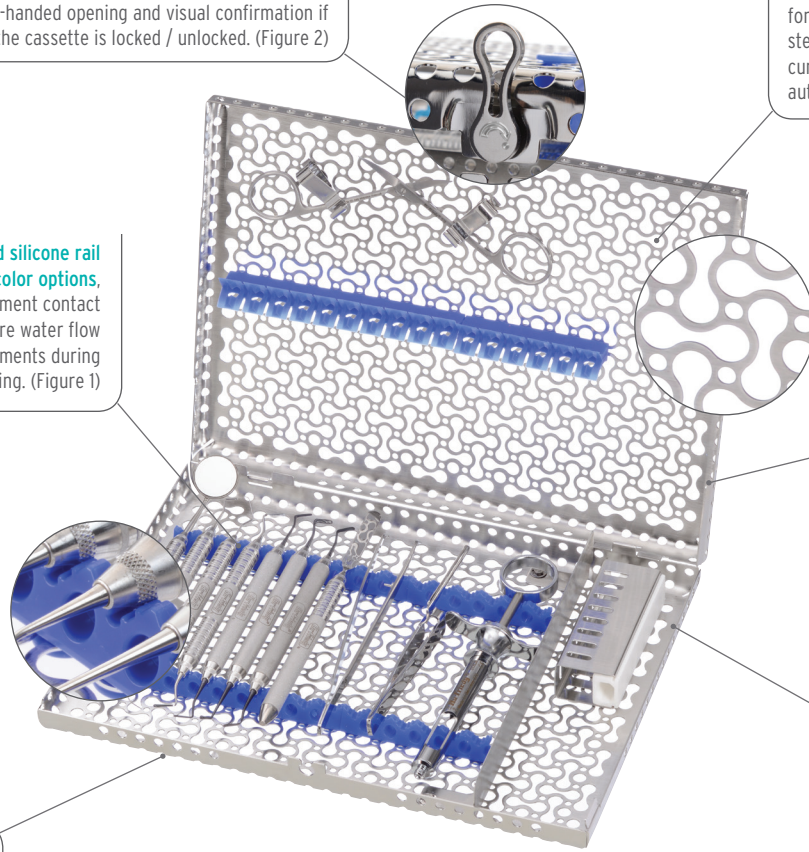

Smooth round corners and slotted edges increase drainage and reduce drying time.

New beveled edge allows for a more ergonomic grasp.



Figure 1

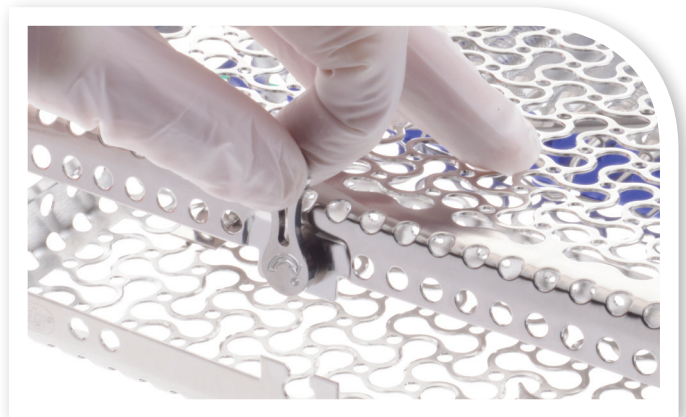

Figure 2

IMS INFINITY SERIES™ CASSETTES & ACCESSORIES



Infinity Series™ Cassettes are made of long-lasting, low-maintenance stainless steel. Soft, colored silicone rails securely hold instruments throughout the processing cycle. Available in over 100 different sizes, configurations and color options, cassettes can be specialized to meet your needs.

Red	IMN6050
Gray	IMN6051
White	IMN6052
Orange	IMN6053
Purple	IMN6054
Yellow	IMN6055
Lavender	IMN6056
Black	IMN6057
Blue	IMN6058
Green	IMN6059
Ocean Blue	IMN60511

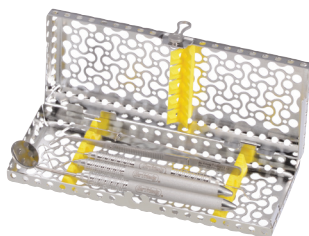

**Exam Cassette
5 Instruments**
Exterior Dimensions
3" x 8" x 1.25"
(76 mm x 203 mm x 32 mm)
Holds 5 instruments.

Red	IMN5080
Gray	IMN5081
White	IMN5082
Orange	IMN5083
Purple	IMN5084
Yellow	IMN5085
Lavender	IMN5086
Black	IMN5087
Blue	IMN5088
Green	IMN5089
Ocean Blue	IMN50811



**Small Cassette
8 Instruments**
Exterior Dimensions
5.5" x 8" x 1.25"
(140 mm x 203 mm x 32 mm)
Holds 8 instruments with an
accessory area.



Red	IMN8120
Gray	IMN8121
White	IMN8122
Orange	IMN8123
Purple	IMN8124
Yellow	IMN8125
Lavender	IMN8126
Black	IMN8127
Blue	IMN8128
Green	IMN8129
Ocean Blue	IMN81211

**Signa-Stat Cassette
12 Instruments**
Exterior Dimensions
6.5" x 10.5" x 1.25"
(165 mm x 267 mm x 32 mm)
Holds 12 instruments with
an accessory area. Fits in
SciCan® STATIM® or the
Midmark M3 autoclave.

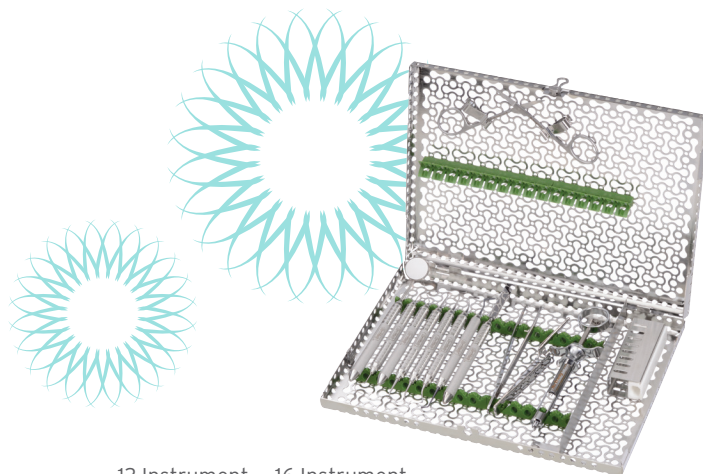

12 Instrument 16 Instrument

Red	IMN4120	IMN4160
Gray	IMN4121	IMN4161
White	IMN4122	IMN4162
Orange	IMN4123	IMN4163
Purple	IMN4124	IMN4164
Yellow	IMN4125	IMN4165
Lavender	IMN4126	IMN4166
Black	IMN4127	IMN4167
Blue	IMN4128	IMN4168
Green	IMN4129	IMN4169
Ocean Blue	IMN41211	IMN41611

**Large Cassette
12 or 16 Instruments**
Exterior Dimensions
8" x 11" x 1.25"
(203 mm x 280 mm x 32 mm)
Holds 16 instruments with an
accessory area.
Also available in 8" x 10.5" x
1.25" size (IMN416xQ) to fit
unique ultrasonic tanks.



CASSETTE ACCESSORIES

IMS CASSETTE BARCODE CLIP

Snap-on Barcode for outside of Cassettes
| **IMS-CABL**

Dimensions: .75" x 2.26" x .067"
(19 mm x 57.4 mm x 1.7 mm)

Contains lasermarked barcode to be used for identification and tracking purposes. Compatible with standard barcode reader. Follows HIBC barcode standards. Lasermark tested to last more than 800 sterilization cycles. (Shown at 50% actual size.)



IMS ENDODONTIC STAND

Hinged, double-lid stand holds endodontic files and reamers. Lid is etched with a ruler to measure stop positions easily from either direction.

IMS Endodontic Stand, Holds 24
| **IMS-1275**

Exterior Dimensions:
2.6" x 2.25" x 1.2"
(67 mm x 57 mm x 30 mm)

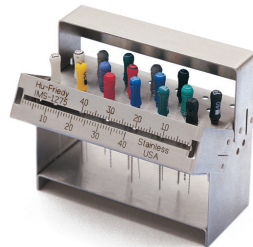

IMS-1275

IMS Endodontic Stand, Holds 48
| **IMS-1275D**

Exterior Dimensions:
2.6" x 2.25" x 1.2"
(67 mm x 57 mm x 30 mm)

AIR WATER SYRINGE CLIPS

Designed to fit large or small Resin Cassettes. Clip holds air/water syringe tip securely in place throughout cleaning and sterilization.

IMS Resin Cassette Clip
| **IMS-1278**

For large resin cassettes

IMS Resin Cassette Clip
| **IMS-1279**

For small two-tier resin cassettes



IMS-1278

AIR AND WATER CLIPS

Designed to fit large or small Signature Series Cassettes. (pictured right) Signature Series IMS clips can be permanently installed in your cassettes

Infinity Series Air/Water Clip | **IM1005N**

Signature Series Air/Water Clip | **IM1005**

Infinity and Signature Series Double-Decker Air/Water Clip | **IM1006**



IMS PARTS BOX

Designed to keep small items such as rubber dam clamps and matrix band retainers organized during the sterilization process.

IMS Large Parts Box | **IMS-1273**

Exterior Dimensions: 3.5" x 1.12" x 1"
(89 mm x 29 mm x 25 mm)

IMS Small Parts Box | **IMS-1271**

Exterior Dimensions: 1.56" x 1.25" x 1"
(40 mm x 32 mm x 25 mm)

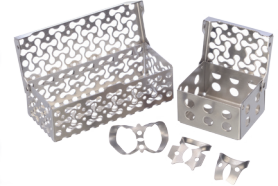

IMS BUR CUSHIONS

A hollow, rectangular, silicone base with a stainless steel lid that is designed to hold burs securely in place during cleaning and sterilization. Hollow design allows drainage and proper cleaning.

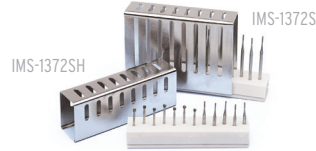

IMS Bur Cushion, Short Lid
| **IMS-1372S**

Holds 12 burs.
Exterior Dimensions:
3.3" x 1.3" x 0.9"
(84 mm x 33 mm x 22 mm)



IMS Bur Cushion, Tall Lid
| **IMS-1372T**

Holds 12 burs.
Exterior Dimensions:
3.3" x 2.44" x 0.9"
(84 mm x 62 mm x 22 mm)

IMS 1/2 Bur Cushion, Short Lid
| **IMS-1372SH**

Holds 6 burs.
Exterior Dimensions:
1.75" x 1.3" x 0.9"
(44 mm x 33 mm x 22 mm)

IMS 1/2 Bur Cushion, Tall Lid
| **IMS-1372TH**

Holds 6 burs.
Exterior Dimensions:
1.75" x 2.44" x 0.9"
(44 mm x 62 mm x 22 mm)

IMS RUBBER DAM CLAMP ORGANIZING BOARD

RDC Organizing Board | **RDCOB**

Dimensions: 4.6" x 2.4" x .375"
(117 mm x 61 mm x 10 mm)



not actual size

Holds up to 8 clamps during sterilization. Fits into cassette accessory area.

HINGED INSTRUMENT CLIPS

Secure scissors, hemostats and air/water syringe tips in lid of cassette.

Hinged Instrument Clips, 2-Pack
| **IM1000**

Hinged Instrument Clips, 6-Pack
| **IM1002**

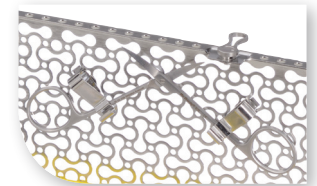

NEEDLE CAP HOLDER

Needle Cap Holders, 2-Pack | **IM1001**

Needle Cap Holders, 6 Pack | **IM1003**

Combination Pack** | **IM1004**

**6 snap-in needle cap holders and 6 snap-in hinged instrument clips. Maintains cap in upright position for one-handed needle recapping.



Complete list of cassette replacement parts can be found on Hu-Friedy.com/IMS-Replacement-Parts



KEY OPINION LEADERS

Key Opinion Leaders' names are recognizable and their work is renowned. Hu-Friedy is honored to be in close association with Key Opinion Leaders, and it is a pleasure to present them to you as individuals full of life, character and vision. Hu-Friedy strives to supply our Key Opinion Leaders of all specialties with the most current offerings and information on our products and services. Being affiliated with outstanding dental professionals only helps to strengthen Hu-Friedy in our mission:

To improve lives through dentistry – smile after smile.

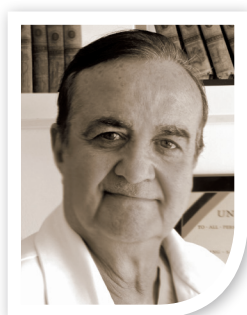

PROFESSOR MARWAN
ABOU-RASS

ABOU-RASS MICROSURGICAL ENDODONTIC KIT*

The instruments selected by Professor Marwan Abou-Rass for his new kit include those few that he relies on for clinical, education, and research activities. The entire collection of "MAR" instruments, which he uses in his work, can be found in the Microsurgical section of Endo Essentials.

A Professor Emeritus of the University of Southern California, Senior Academic Consultant at the Riyadh Military Hospital and General Director of the Prince Abdul- Rahman Advanced Dental Institute (PAADI), in Riyadh, Saudi Arabia, this Key Opinion Leader was instrumental in developing our apical product line.

Large Signature Series 16 Instrument Cassette – Blue, or Large Signature Series 16 Instrument DIN Cassette – Blue	IM4168 or IMDIN138S
IMS Signature Cassette Clips, 2	I1000
#9 Molt Periosteal Elevator	P9
#1 Henahan Retractor	TRH1
#3 Abou-Rass Endo Excavator DE	MAR-C3
#3 Abou-Rass Surgical Curette SE	MAR-SC3
#1 Abou-Rass Endo Explorer DE	MAR-EX1
#DG16/17 DE Endodontic Explorer	EXDG16/17
#1 Abou-Rass Straight Apical Condenser	MAR-SAC1
#1 Abou-Rass Angulated Apical Condenser	MAR-AAC1
#3 Abou-Rass Straight Burnisher	MAR-SB3
#3 Abou-Rass Burnisher SE	MAR-B3
#50L Fox Tissue Pliers w/Lock	TP50L
#1 Velvart Endo Satin Steel Micro Mirror	MMVEL1
#2 Velvart Endo Satin Steel Micro Mirror	MMVEL2
Metzenbaum Perma Sharp Scissors Cv/Bl	S5055
Crile-Wood Perma Sharp Needle Holder	NH5038
Halsey Perma Sharp N.H., Serrated	NH5037
#4 Kramer-Nevins DE Curette	SKN4
Also available in Infinity Series™ Cassettes and Infinity Series™ DIN Cassettes	IMN4168 or IMEDIN1885

*Add cassette clips, to anchor instruments to the top of your cassette, and add accessories as needed.



KEY OPINION LEADER KITS



DR. RAINER HAHN



HAHN ENDODONTIC MICROSURGICAL KIT*

Large Signature Series, 16 Instrument Cassette – Blue, or Large Signature Series, 13 Instrument DIN Cassette – Blue	IM4168 or IMDIN138
Microsurgical Scissors, Straight, Castroviejo, 18 mm	SPV
Microsurgical Tissue Pliers, Curved, 18 mm	TPSLCOCMN
Microsurgical Needle Holder, Straight, Castroviejo	NHDPV
Microsurgical Scalpel Handle	SHDPV
Microsurgical Periosteal	PH26M
Spahr Periosteal (Optional)	PPSPAHR6
Mini Scalpel Blade	MB69
Labanca Periosteal, #6 Satin Steel Handle	PPLABANCA6
Also available in Infinity Series™ Cassettes and Infinity Series™ DIN Cassettes	IMN4168 or IMEDIN138



DR. NOAH CHIVIAN



DR. DONALD ARENS



CHIVIAN-ARENS ENDODONTIC SURGERY KIT**

| ENDO-SXKIT

Large Signature Series 12 Instrument Cassette – Gray, or Large Signature Series, 13 Instrument DIN Cassette – Gray	IM4121 or IMDIN131
23/UNC15 University of North Carolina Expro	XP23/UNC15
1 Explorer	EXD1
5 Scalpel Handle	10-130-05
149 Periosteal	P149
2/4 Molt Surgical Curette	CM2/4
1 Hourigan Retractor	PH1
85 Lucas Surgical Curette	CL85
87 Lucas Surgical Curette	CL87
17/18 Indiana University Curette	SIU17/18
13/14 Columbia Curette	SC13/14
18 Iris Scissors Curved, Delicate	S18
Mathieu-Kocher Perma Sharp Needle Holder	NH5074
Also available in Infinity Series™ Cassettes (sold separately) and Infinity Series™ DIN Cassettes	IMN4161 or IMEDIN131

*Add cassette clips, to anchor instruments to the top of your cassette, and add accessories as needed. **Cassette sold separately.



DR. BERTRAND KHAYAT

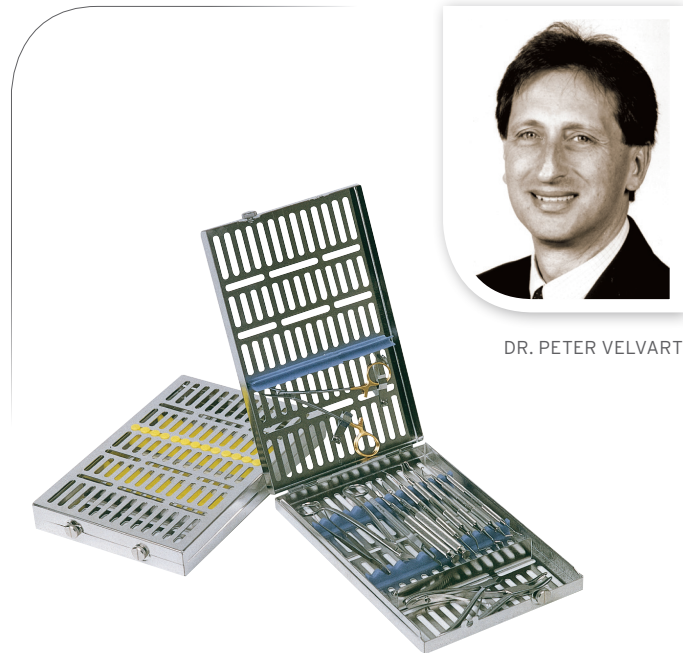

DR. PETER VELVART

KHAYAT ENDODONTIC SURGICAL KIT*

| **IMKHAYAT1** (Europe) | **IMKHAYAT2** (North America)

Large Signature Series 20 Instrument Cassette – Blue, or Large Signature Series 18 Instrument DIN Cassette – Blue	IM4208 or IMDIN138S
Scalpel Handle	10-130-05E
Microsurgical Scalpel Blade/Mirror Handle, Stainless Steel	SHDPV
Micro Mirror Round, 2.5 mm	MM4
Khayat Apical Plugger, with Satin Steel Handle	PLGBK6
Khayat Instrument, with Satin Steel Handle	PF18ABK6
85 Lucas Surgical Curette, Spoon Shape, Short Satin Steel Handle	CL856
Velvart Condenser, with Satin Steel Handle	PLGVEL56
NEW! Perma Sharp General Tissue Pliers, 6" (15 cm)	TP5072
PR-3 Prichard Periosteal, with Satin Steel Handle	PPR3S6
13/14 Columbia Curette, Universal with Satin Steel Handle	SC13/146
34/35 Jacquette Scaler, Miniature, Posterior with Satin Steel Handle	SJ34/356
89/92 Carver Discoid-Cleoids, with Satin Steel Handle	CD89/926
DG 16/17 Endodontic Explorer, with Satin Steel Handle	EXDG16/176
Cawood-Minnesota Retractor	CRM2
NEW! Perma Sharp Needle Holder, Castroviejo Curved, Round Handle, 5.5" (14 cm)	NH5021RC
14 LaGrange Double-Curved Super Cut Scissors	S14SC
Also available in Infinity Series™ Cassettes (sold separately) and Infinity Series™ DIN Cassettes	IMN4208 or IMEDIN188

VELVART ENDODONTIC MICROSURGICAL KIT*

Large Signature Series 16 Instrument Cassette – Blue, or Large Signature Series 13 Instrument DIN Cassette – Blue	IM4168 or IMDIN138
Microsurgical Mirror, 3 mm	MM4
Microsurgical Mirror, 5 mm	MM5
Microsurgical Mirror, 7 mm x 2 mm	MM7
Microsurgical Mirror, 9 mm x 3 mm	MM8
Microsurgical Needle Holder, 18 cm, Straight	NHDPV
Microsurgical Mirror Handle/Micro Scalpel Handle	SHDPV
Mini Scalpel Blade, 12 per pack	MB67
Mini Scalpel Blade, 12 per pack	MB69
Micro Surgical Scissors, 18 cm	SPV
Micro Tissue Pliers, 18 cm, Straight	TPDAPV
Micro Tissue Pliers, 18 cm, Angled	TPDSCPV
Micro Tissue Pliers, 18 cm, Straight	TPDSSPV
Also available in Infinity Series™ Cassettes and Infinity Series™ DIN Cassettes	IMN4168 or IMEDIN138

*Add cassette clips, to anchor instruments to the top of your cassette, and add accessories as needed.



KEY OPINION LEADER KITS

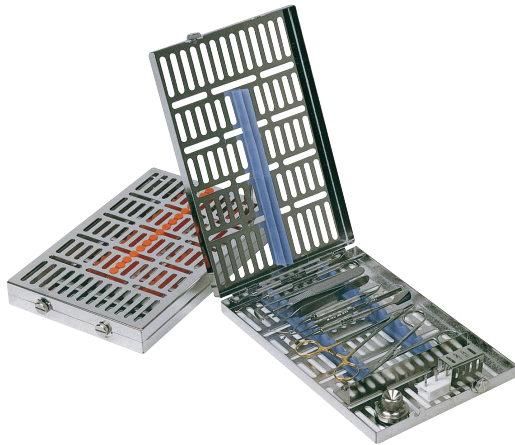

PROFESSOR DR. PIERRE MACHTOU

MACHTOU ENDODONTIC PRE-TREATMENT KIT*

Large Signature Series 16 Instrument Cassette – Blue, or Large Signature Series 16 Instrument DIN Cassette – Blue	IM4168 or IMDIN168
IMS Signature Cassette Clips, 2	I1000
IMS Bur Cushion, Short Lid, Holds 12	IMS-1372S
Articulation Paper Pliers	APF2E
Hollenbach Carver, #6 Satin Steel Handle	CVHL3S6
Universal Pliers	DPU17
Endodontic Excavator, #6 Satin Steel Handle	EXC32L6
Explorer, #30 Handle, 12.5 mm	EXS6XL
Kelly Hemostat, 14 mm	H1
5 Front Surface Mouth Mirror	MIR5
#6 Satin Steel European Mirror Handle	MHE6
Qulix® UNC Color-coded Probe, #6 Satin Steel Handle	PCPUNC156
Loesche 2 Composite/Filling, #6 Satin Steel Handle	PFIGML26
Rubber Dam Frame, Adult	RDAF6
#1 Rubber Dam Clamp	RDCM1
#212 Rubber Dam Clamp	RDCM212
#26N Rubber Dam Clamp	RDCM26N
#4 Rubber Dam Clamp	RDCM4
#8 Rubber Dam Clamp	RDCM8
#9 Rubber Dam Clamp	RDCM9
#W8A Rubber Dam Clamp	RDCMW8A
Rubber Dam Clamp Forceps	RDF4
Iris Scissors, Straight, Delicate, 11.5 cm	S17
204S Sickle Scaler, #6 Satin Steel Handle	S204SD6
Anesthetic Syringe, Type CW	SYRCWE
Also available in Infinity Series™ Cassettes and Infinity Series™ DIN Cassettes	IMN4168 or IMEDIN168

MACHTOU ENDODONTIC TREATMENT KIT*

Large Signature Series 16 Instrument Cassette – Blue or Large Signature Series 16 Instrument DIN Cassette – Blue	IM4168 or IMDIN168
IMS Signature Series Large Parts Box	IMS-1273
Cement Spatula	CSA6
1 Perry Dressing Pliers	DP1
DG16 Explorer, #7 Satin Steel Colours Handle	EXDG167
5 Front Surface Mouth Mirror, Simple Stem	M5C
#6 Satin Steel European Mirror Handle	MHE6
10 Root Canal Plugger	RCP10
11 Root Canal Plugger	RCP11
8 Root Canal Plugger	RCP8
9 Root Canal Plugger	RCP9
1/2 Machtou Root Canal Plugger	RCPM1/2
3/4 Machtou Root Canal Plugger	RCPM3/4
11T Spreader	RCSD11T
Iris Scissors, Straight, Delicate, 11.5 cm	S17
Also available in Infinity Series™ Cassettes and Infinity Series™ DIN Cassettes	IMN4168 or IMEDIN168

*Add cassette clips, to anchor instruments to the top of your cassette, and add accessories as needed.



DR. THOMAS VON ARX



VON ARX APICAL MICROSURGERY INSTRUMENT KIT*

Large Signature Series 20 Instrument Cassette – Blue, or Large Signature Series 18 Instrument DIN Cassette – Blue	IM4208 or IMDIN138S
Signature Series Cassette Clips, 2	I1000
Scalpel Handle	10-130-05E
#15C Scalpel Blades	10-256-15
84 Lucas Surgical Curette, #6 Satin Steel Handle	CL846
86 Lucas Surgical Curette, #6 Satin Steel Handle	CL866
32L Excavator, #6 Satin Steel Handle	EXC32L6
E1 Excavator (12-9-15), #6 Satin Steel Handle	EXCE16
Halsted-Mosquito Hemostat, Straight, 4.72" (12 cm)	H4
Abou-Rass Microsurgical Excavator	MAR-C1
Apical Burnisher/Plugger, Large, Left	MCBLL
Apical Burnisher/Plugger, Medium, Left	MCBLM
Apical Burnisher/Plugger, Small, Left	MCBLS
Apical Burnisher/Plugger, Large, Right	MCBRL
Apical Burnisher, Medium, Right	MCBRM
Apical Burnisher, Small, Right	MCBRS
Microsurgical Explorer	MEX16
Markel Adult Mouth Prop	MP54
Perma Sharp Needle Holder Castroviejo, Straight	NH5024
Perma Sharp Needle Holder Crile-Wood	NH5038
Colorvue® Probe Tips, 12 pcs (3-6-9-12)	PCV12PT
Colorvue Satin Steel Handle	PH6
Buser Periosteal, #6 Satin Steel Handle	PPBUSER6
3/9A Prichard Periosteal, #6 Satin Steel Handle	PPR3/9A6
Microsurgical Scissors, Curved, Titanium	STMBH
8A XTS® Satin Steel Composite Filling Instrument	TNPF18A
Tissue Pliers Micro, Straight, Titanium	TPASTMBH
Also available in Infinity Series™ Cassettes and Infinity Series™ DIN Cassettes	IMN4208 or IMEDIN188

*Add cassette clips, to anchor instruments to the top of your cassette, and add accessories as needed.
 †Add a RDP or RDPA Rubber Dam Punch to your kit, and additional clamps such as the RDCM12A – paired with RDCM13A.

ENDODONTIC INFINITY KIT**

Large Infinity 12 Instrument Cassette – Gray, or Large Signature Series, 13 Instrument DIN Cassette – Gray	IMN4121 or IMEDIN131
#6 Satin Steel Mirror Handle	MH6
4 Front Surface Mouth Mirror	MIR4
DG16 Endo Explorer, #6 Satin Steel Handle	EXDG166
1 Locking Endo Pliers	EPL1
31L Endo Excavator, #6 Satin Steel Handle	EXC31L6
D11 Nickel Titanium Endo Spreader	RCSD11NT
1/3 Endo Plugger	RCP1/3
5/7 Endo Plugger	RCP5/7
9/11 Endo Plugger	RCP9/11
1 Glick Blade/Endo Plugger	RCPGL1
Miller Articulating Paper Forceps	APF2
CW Aspirating Anesthetic Syringe	SYRCW
Rubber Dam Forceps	RDF
#1 Rubber Dam Clamp	RDCM1
#2 Rubber Dam Clamp	RCDM2
#9 Rubber Dam Clamp	RDCM9
#26N Rubber Dam Clamp	RDCM26N
Endo Stand, Holds 24 Files and Reamers	IMS-1275
Small Parts Box	IMS-1271
Bur Cushion Short Lid, Holds 12	IMS-1372S
A/W Syringe Tip Clip	IM1005
Also available in Infinity Series™ Cassettes and Infinity Series™ DIN Cassettes	IMN4128 or IMEDIN131

ENDODONTIC INFINITY KIT 2**

Large Infinity 12 Instrument Cassette – Gray, or Large Signature Series, 13 Instrument DIN Cassette – Gray	IMN4121 or IMEDIN131
#6 Satin Steel Mirror Handle	MH6
4 Front Surface Mouth Mirror	MIR4
5 Explorer	EXD5
CP-12 Probe	PCP12
DG16 Endo Explorer	EXDG16
1 Locking Endo Pliers	EPL1
31L Endo Excavator	EXC31L
D11T Endo Spreader	RCSD11T
5/7 Endo Plugger	RCP5/7
1 Glick Blade/Endo Plugger	RCPGL1
Bur Cushion	IMS-1372S
Small Parts Box	IMS-1271
#1 Rubber Dam Clamp	RDCM1
#2 Rubber Dam Clamp	RCDM2
#9 Rubber Dam Clamp	RDCM9
#26N Rubber Dam Clamp	RDCM26N
Rubber Dam Forceps	RDF
Miller Articulating Paper Forceps	APF2
Also available in Infinity Series™ Cassettes and Infinity Series™ DIN Cassettes	IMN4128 or IMEDIN131

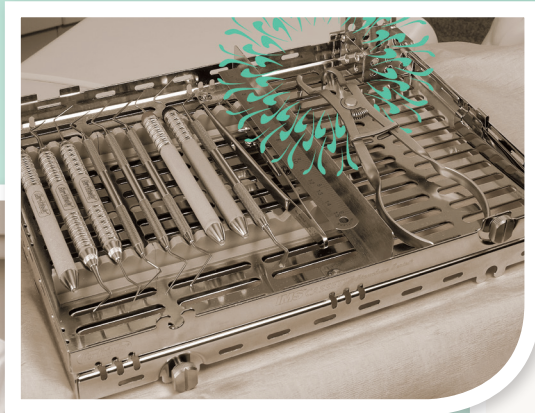

For more information about Hu-Friedy's Total Solutions visit **HU-FRIEDY.COM**

FPO BOX

PERIODONTAL	RESTORATIVE	ORTHODONTIC	INSTRUMENT MANAGEMENT	ENDODONTIC	SURGICAL	ULTRASONIC SCALING

Hu-Friedy Mfg. Co., LLC: 3232 N. Rockwell St. | Chicago, IL 60618 | USA
Telephone: 1-800-Hu-Friedy (1-773-975-6100) | Website: Hu-Friedy.com

©2017 Hu-Friedy Mfg. Co., LLC. All rights reserved. The contents of this Product Catalog including, but not limited to, all text, photographs and graphics, are the sole and exclusive property of Hu-Friedy Mfg. Co., LLC and may not be copied, reproduced or distributed without prior written permission. HF-654/0617

